



GHAZI ELEVATOR SERVICES

ADD: Suit#1, 46-Empress Road Behind Empress Tower Lahore - Pakistan

TEL: 042 - 36292654

MOB: 03254580889

www.ghazielevatorservices.com

EMAIL: info@ghazielevatorservices.com

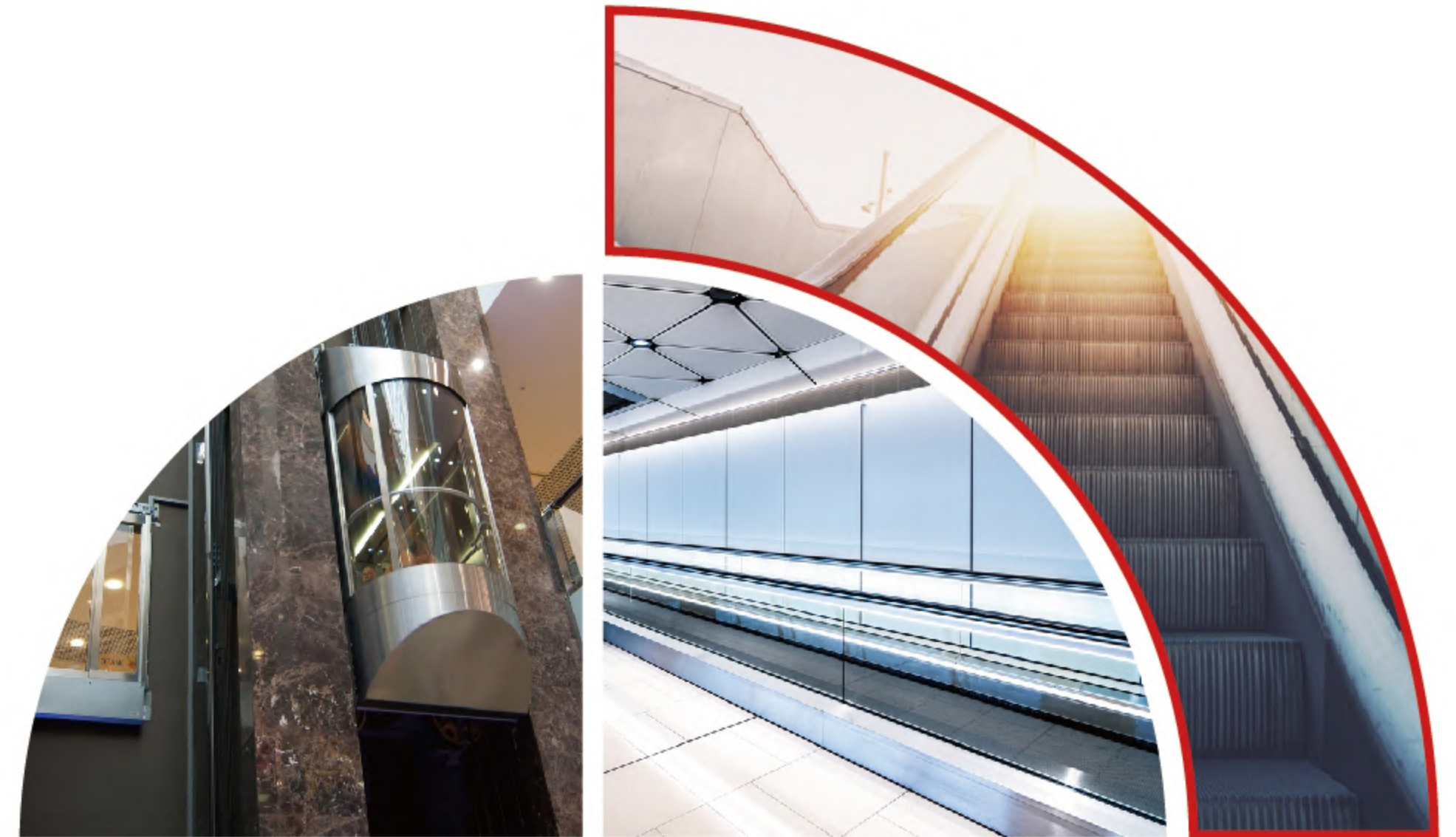

GHAZI ELEVATOR SERVICES

ELEVATOR/ESCALATOR

A SAFETY ELEVATOR ENVIRONMENT FROM GHAZI ELEVATOR

COMPANY PROFILE

About Us

About Ghazi Elevator Services.

Welcome to Ghazi Elevator Services, a leading provider of elevator, lift, and escalator solutions since 2009. With over four decades of industry experience, we have established ourselves as a trusted name in the vertical transportation sector. Our commitment to excellence and customer satisfaction has enabled us to successfully complete over 250 elevator and lift projects across various industries. Our Expertise and Experience

With a legacy spanning more than 12 years, Ghazi Elevator brings a wealth of knowledge and expertise to every project. Our team of highly qualified staff and engineers, consisting of more than 10 dedicated professionals, is committed to delivering exceptional results. Their vast experience and technical skills allow us to tackle projects of any size and complexity, ensuring superior quality and precision in our work.

Our Vision

Our vision at Ghazi Elevator Services is to be the leading provider of elevators, lifts, and escalators solutions, recognized for our commitment to excellence, innovation, and customer satisfaction. We strive to transform the vertical transportation industry through cutting-edge technologies and superior service.

Our Mission

Our mission is to deliver exceptional elevator and lift solutions that enhance vertical mobility, safety, and efficiency for our clients. We aim to exceed customer expectations by providing reliable installations, prompt maintenance and repair services, and innovative troubleshooting solutions. We are dedicated to building long-term relationships with our clients based on trust, integrity, and exceptional service.





Our Clients



OFFICIAL TRADE PARTNER



**COMPLETE ELEVATORS & ESCALATORS
AND PARTS WITH ACCESSORIES**

TECHNICAL STRENGTH

Effective, Speedy and High-End Intellectual Design

It gives first priority to effectiveness in vertical transport field. In order to fully optimize the service efficiency of the elevator system, SUNNY elevator fulfills the intellectual managements such as multi-computer, modular and network control etc, through fully computerized intellectual control system.

It instantly feeds back the elevator running conditions. It provides the passengers with the most efficient gold-collar services.



Serial Communication Technology

It adopts the network communication, which brings great reduction of the wires, enhancement of the reliability and less installation period.

Microcomputer Group Supervision Management System

Duty on/off rush-hour running mode: It satisfies the running requirements in the rush hours of duty on/off the public occasions in the office building and etc.

Even operation mode: It adopts the minimized waiting period distribution principle with the prompt and reasonable elevator response.

Idle running mode: The elevators have been evenly distributed in the designated area to wait far call in idle times in order to guarantee the quick and timely response towards the outer balls.

Remote Control System Ensures Intelligent Supervision

Through wire or wireless communication, the operation status and success situation of passengers in elevators are real-time protected in remote control center. Malfunctions are excluded before occurrence and nip them in the bud to ensure the safety of passengers.



Mute Braking Control Technology

- ⌘ Compared with the traditional voltage open-loop control.
- ⌘ It applies the more accurate current closed-loop control mode.
- ⌘ It controls various steps of action speed and braking torque of the brake.
- ⌘ It greatly reduces noise in brake action.
- ⌘ It enhances the comfortable travel.

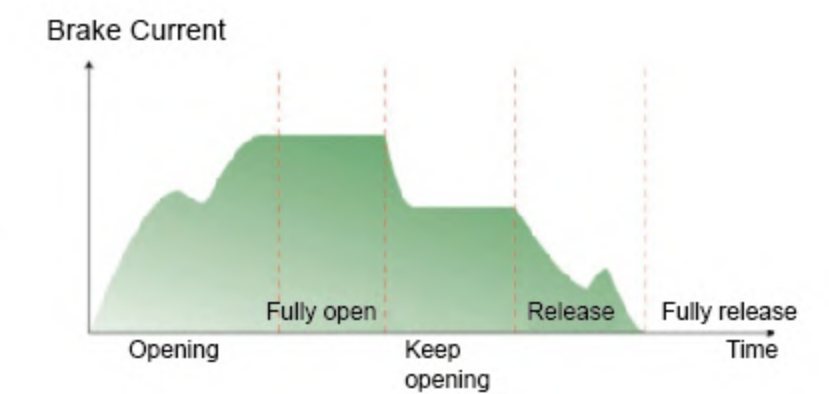

Top Advanced Door Operator System

The door operator control system of SUNNY elevator applies dual control system. One group is controlled by main controller of control cabinet.

The other one is by door operator controller, which greatly reduces non-opening accidents due to trouble of door machine control.

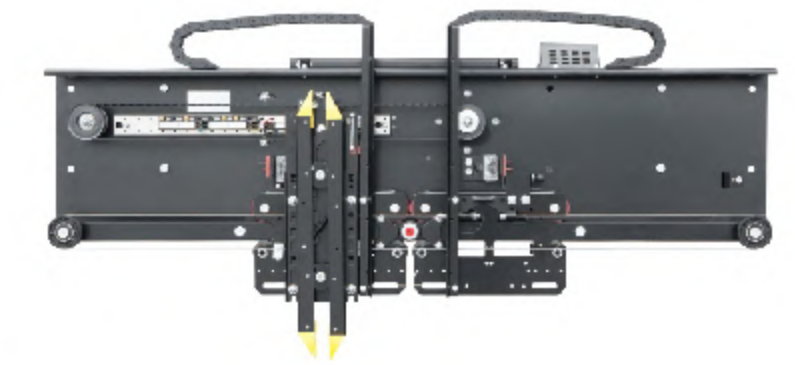

TOP TECHNICAL

To Give You A Wholly New Experience



The business field,high efficiency first, in order to fully optimize the service efficiency of business of elevator. Ghazi by using the computer intelligent control system.Realizes the multi microcomputer module, network control and other intelligent management. The elevator operation provides instant feedback,offers the most efficient service for passengers.

Supervision System

Group supervision system of SUNNY Elevator is high-speed network processing serve center. It can calculate the best elevator running mode in the building. The out-standing traffic control performance comes from parallel "fuzzy computing" method.

The processing system is based upon the quick and effective genetic algorithm. It can choose the best travel route for the passengers so that they get the prompt service under any of the traffic conditions.

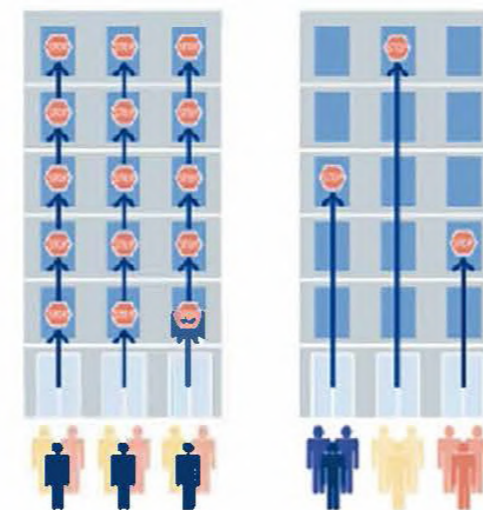

Fingerprint Identification

Layer with finger print identification of the elevator control system is an utility model involves the electronic technology, and control the use of fingerprints identification residents elevator parked in the designated floor, make the multi-storey building entrance guard management improved, peaking time to other person into the building occupants harassment problems has solved.



Intelligent Card(IC) System Realizes Scientific and Safe Management of Rights and Authority

In accordance with the requirements of users, intelligent IC card management system can be equipped to conduct real-name system or authority management, effectively avoid access of visitors and improve the safety of the building.



Through the contact less card reader at the entrance floor,automatically login uplink button.

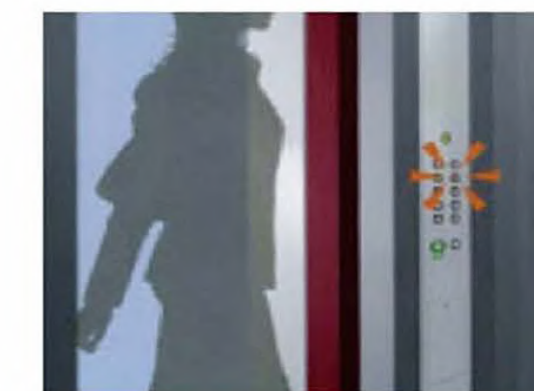

After elevator arrived, it would automatically go to the target floor, bottons for other floors would not work even if you click them.

ENERGY SAVING FROM GHAZI ELEVATOR

Energy Feedback Technology

Highly energy-saving energy feedback technology is based upon double-PWM control. It feeds back the pollution-less regenerated green electric energy that is originally consumed by energy-consumption resistance to other power equipment. It thus averagely saves over 30% of energy compared with the ordinary VVVF elevators. It completely satisfied the related national electric energy quality standards.

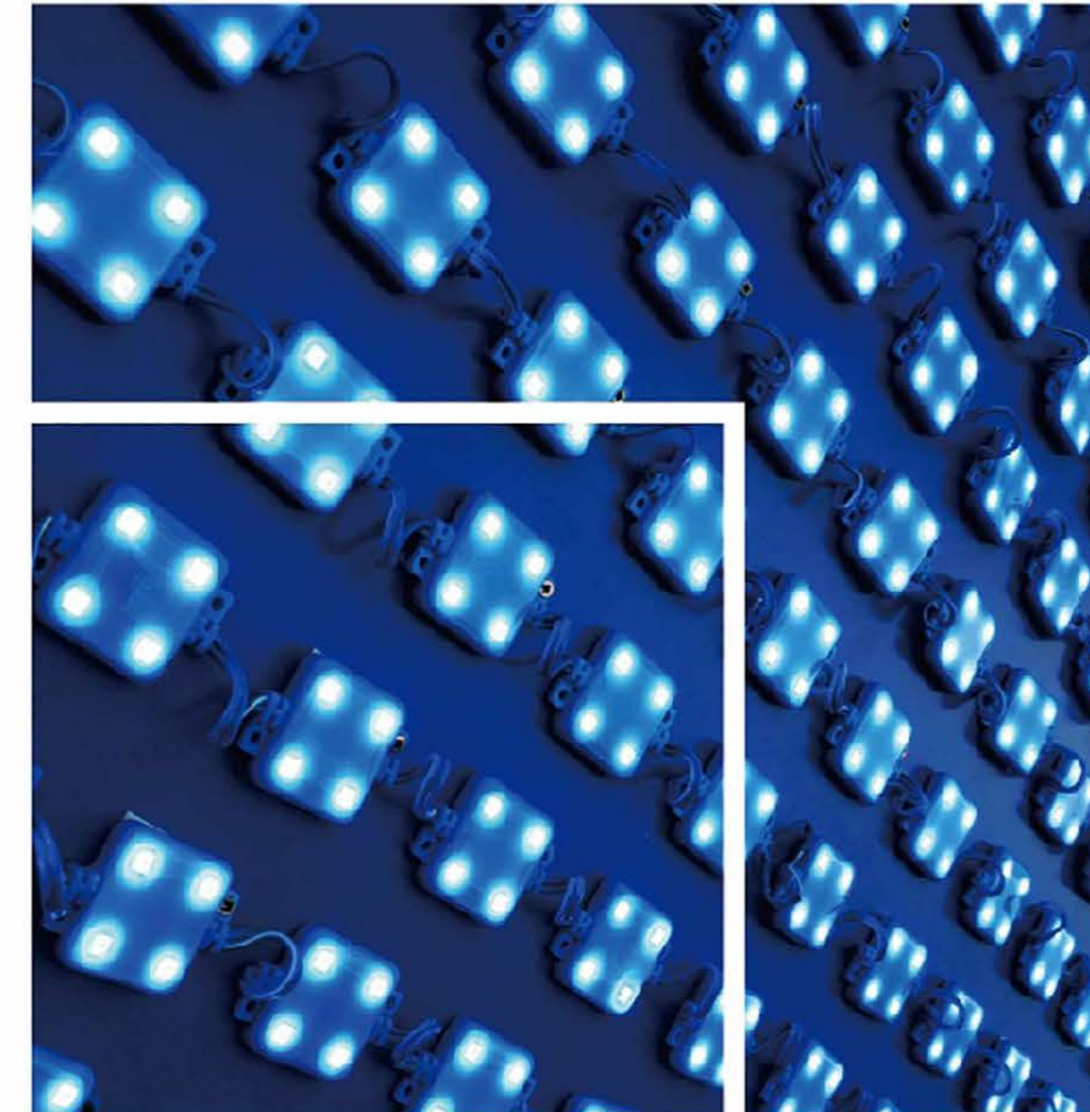
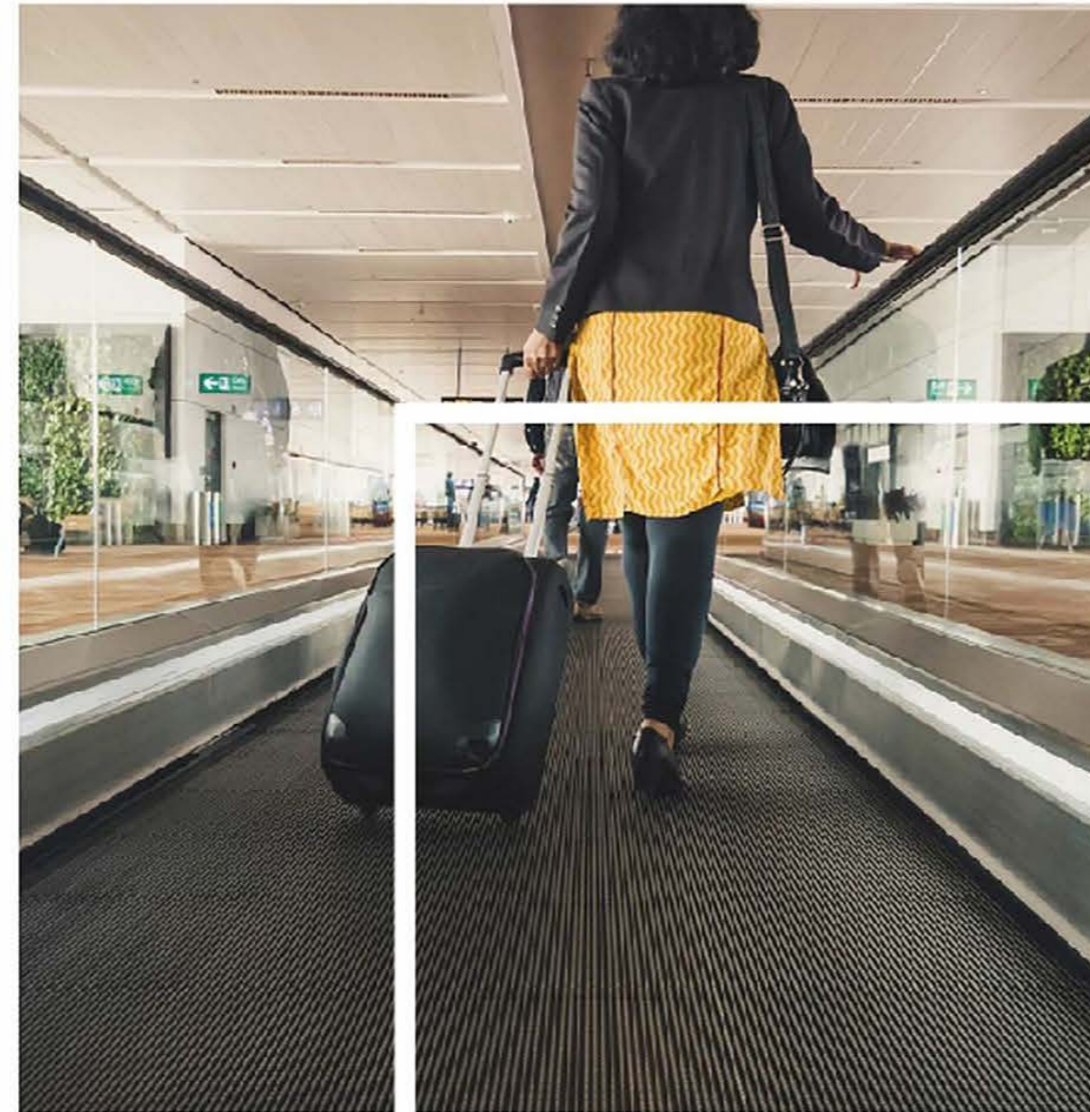
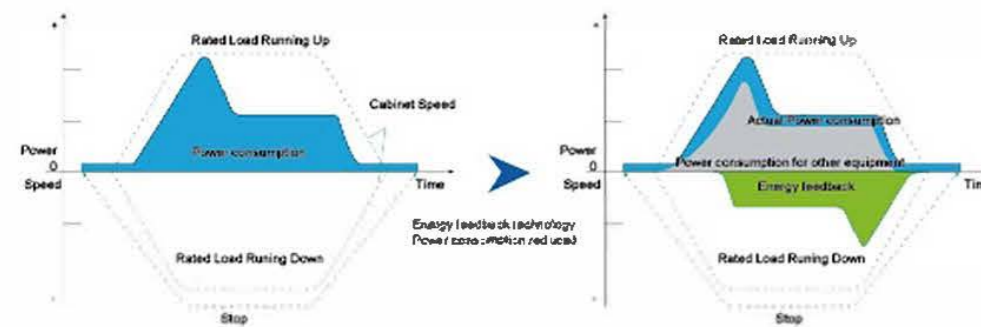

LED Automatic Lighting in the Car

It adheres to the product idea of SUNNY Elevator. SUNNY elevator innovatively applies LED car lighting device. It has the advantages, such as safe, effective, radiation-free, easy maintenance etc. It is a model example of energy-saving in modern and well-off life configuration of passenger elevator series includes automatic shut-off function of car enjoying and fan. It gives a full play of human-centered design to SUNNY Elevator.

New Generation Permanent Magnet Synchronous Gearless Traction Machine

It can save over 40% of energy. It needs no grease renewal without oil pollution. Which brings peacefulness and refreshment.

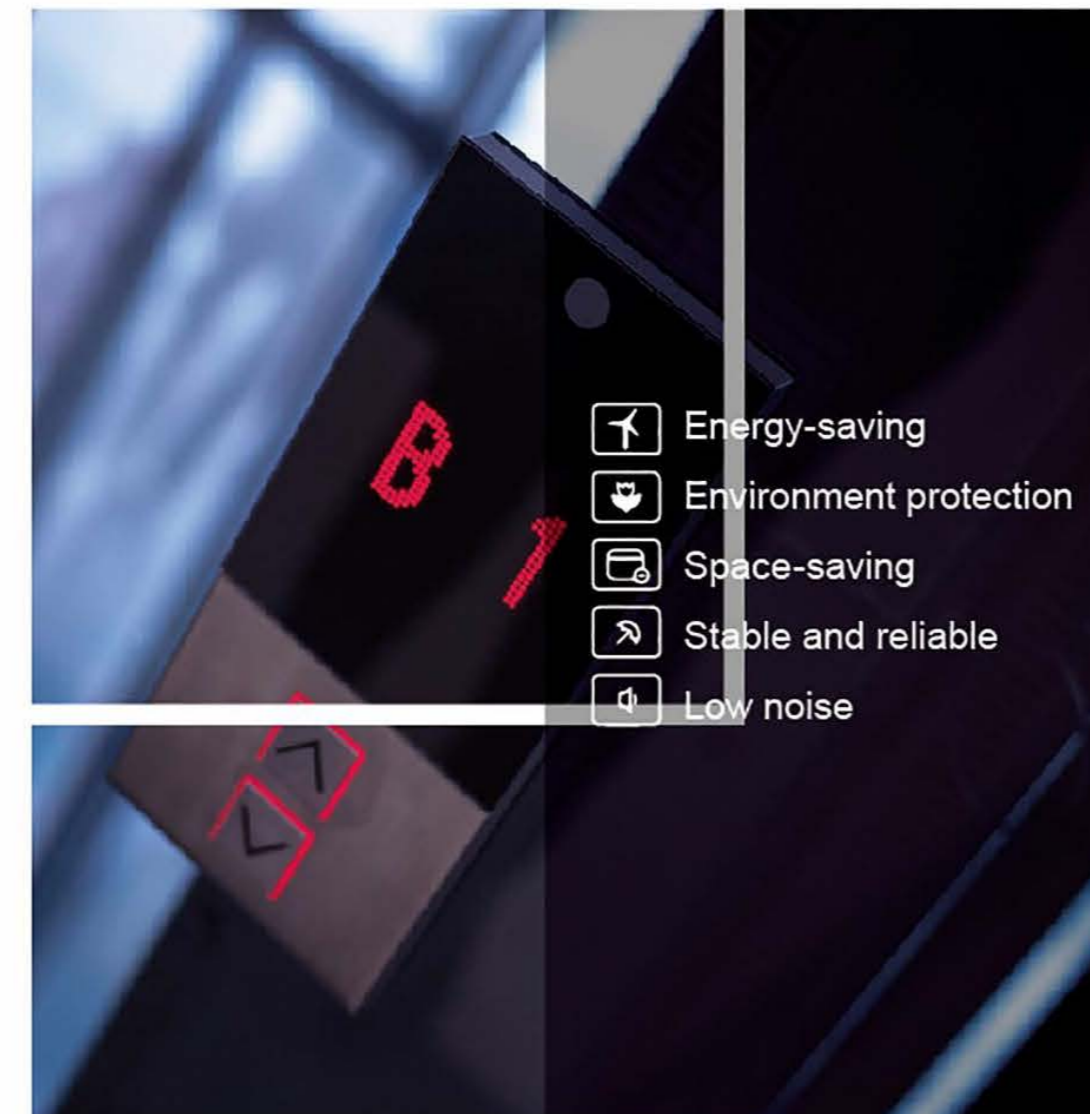
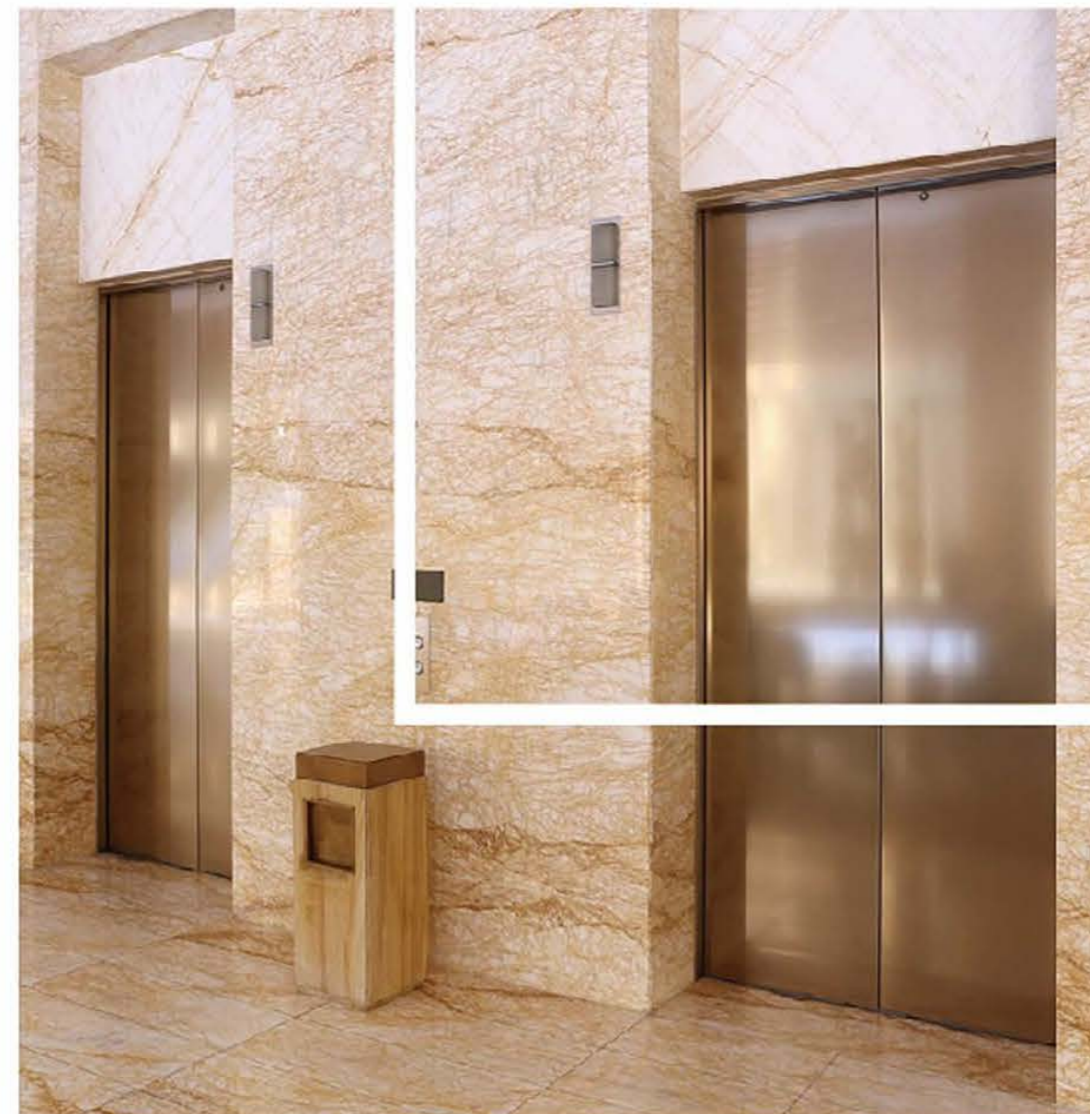

Five Advantages

- It is non-calorific converts over 90% of electric energy into optical energy.
- Longer service life and fewer power consumption.
- The elevators consume 20%~35% less of power.
- It does not add heavy metals during chip assembling and processing. It excludes any hazardous materials.
- It can be recycled and reused after being discarded.

HIGH SPEED ELEVATOR

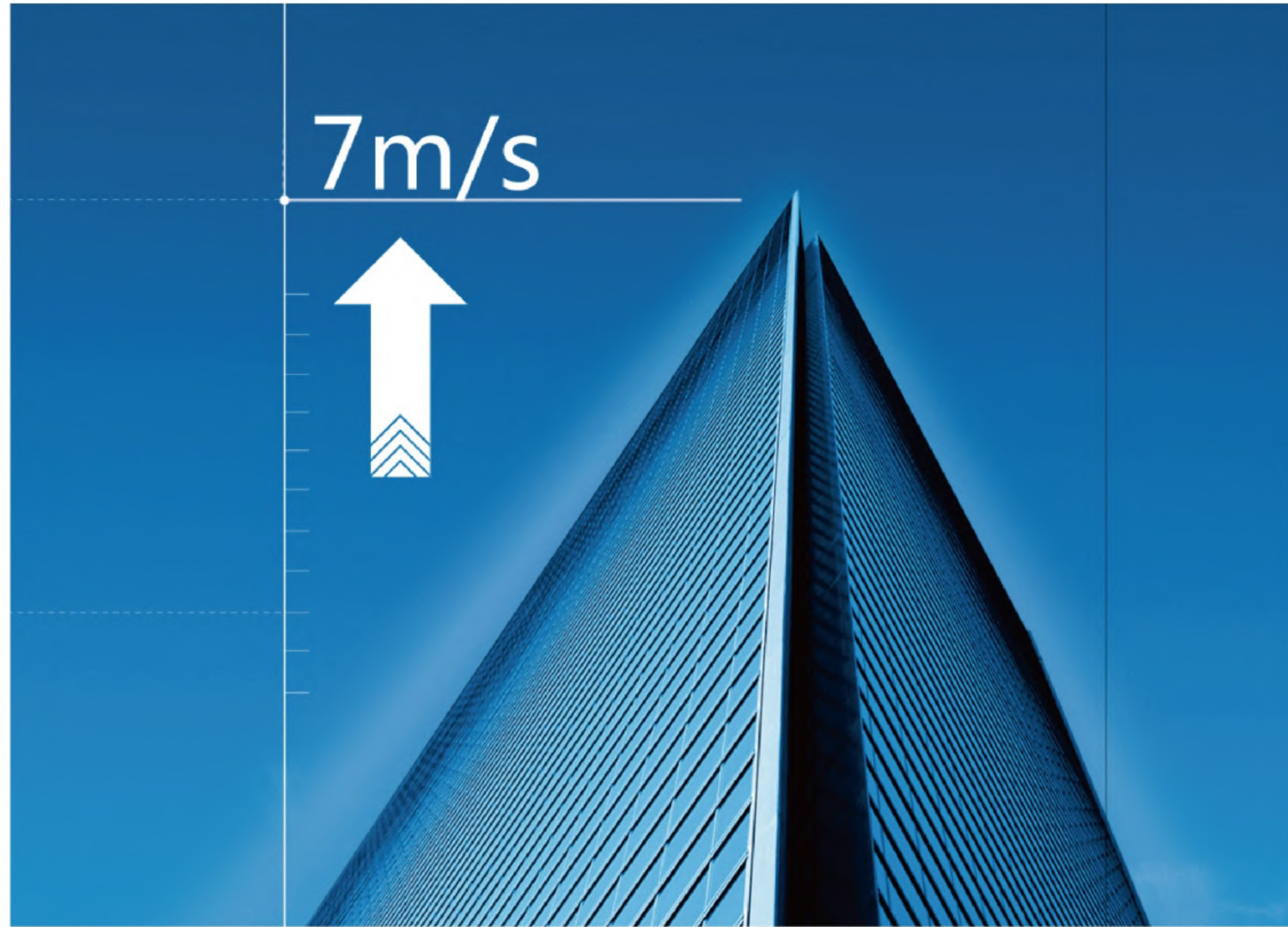

High Speed Elevator Construction Sketch

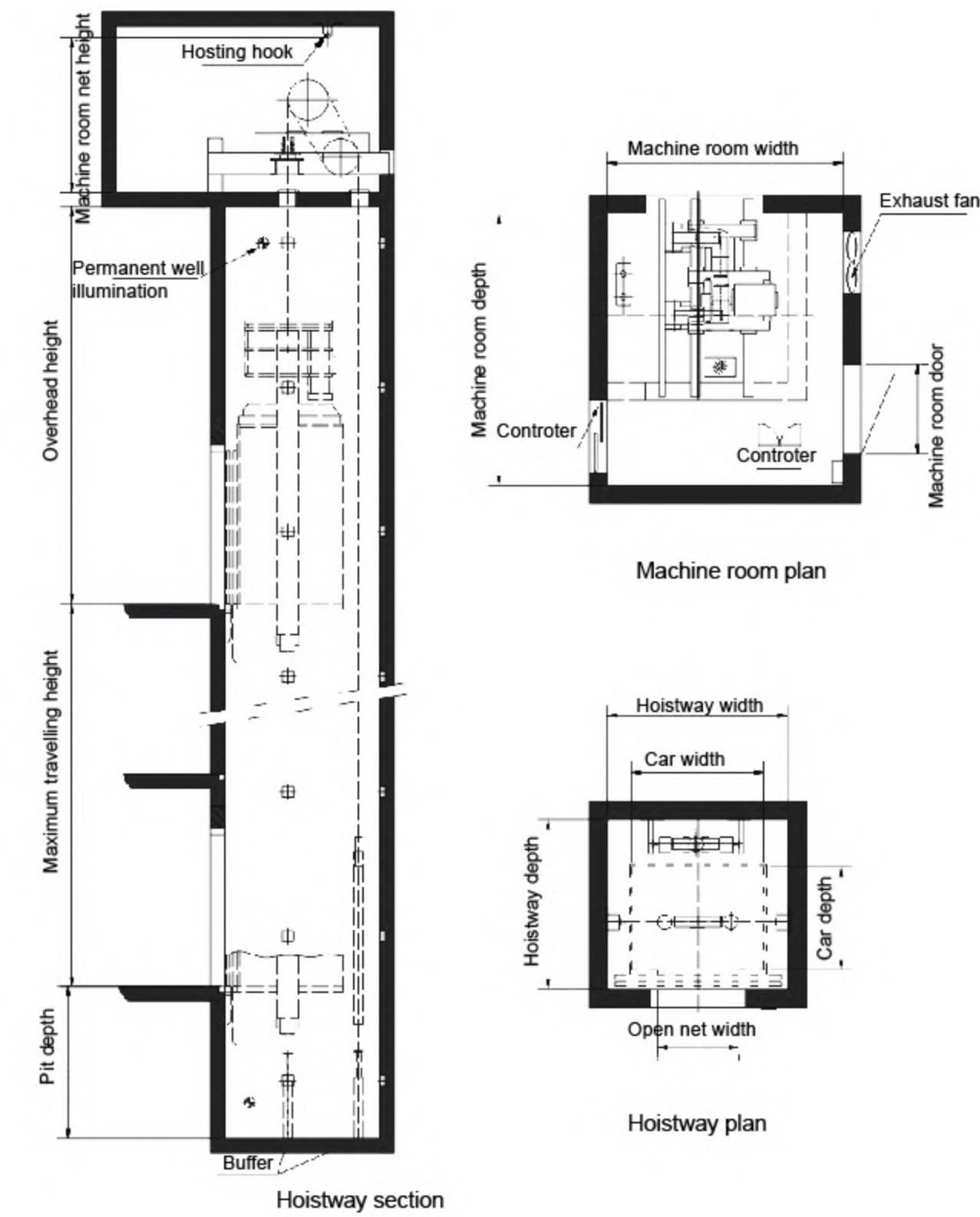

🔻 The Extremely Comfortable Travel

A shock-absorbing device is set between the car body and holder to isolate vibration. It superiorly buffers vibration during the elevator running process. It reduces the car vibration and prompts the conformable travel to vast passengers. The combined car wall connection ensures mute effects in the car, the stable and enclosed air pressure.

🔻 High Speed Serials Specification Table

Target market	The medium & high grade of the commercial buildings
Control system	VVVF
Traction machine	Permanent magnet synchronous & gearless
Door machine	VVVF door machine
Net car height	2800mm
Rated load(kg)	1050/1150/1250/1350/1600/2000
Rated speed(m/s)	2.5/3.0/4.0/5.0/6.0/7.0
Max.lighting height(m)	120/150/180/220/260/300
Max.group supervision No.	8

🔻 Car Vibration System

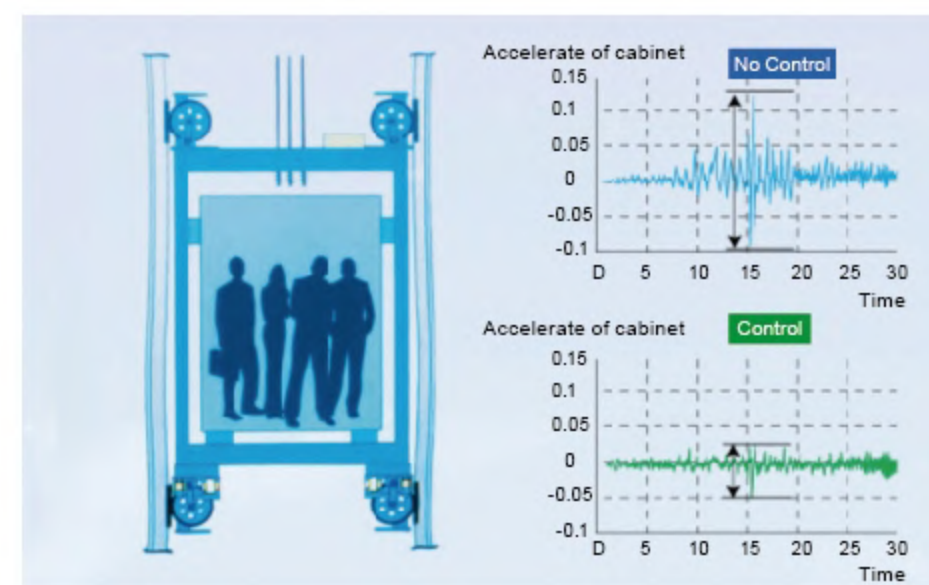

High speed elevator parameter table

Load (kg)	Speed (m/s)	Size of entrance (mm)	Size of car (mm)	Size of hoistway (mm)	Size of machine room (mm)	Overhead height (mm)	Pit depth (mm)	Max travelling height (mm)
800	2.5	800*2100	1400*1350*2450	2200*2250	3000*3700	5200	2200	150
1000	2.5	900*2100	1600*1400*2450	2200*2250	3000*3700	5200	2200	150
	3.0					5500	3100	150
	3.5					5800	3700	180
	4.0					6200	4000	180
1050	2.5	900*2100	1600*1500*2450	2200*2300	3000*3700	5200	2200	150
	3.0					5500	3100	150
	3.5					5800	3700	180
	4.0					6200	4000	180
1150	2.5	900*2100	1800*1400*2450	2450*2300	3200*3700	5200	2200	150
	3.0					5500	3100	150
	3.5					5800	3700	180
	4.0					6200	4000	180
1250	2.5	1100*2100	1950*1400*2450	2600*2300	3200*3700	5200	2200	150
	3.0					5500	3100	150
	3.5					5800	3700	180
	4.0					6200	4000	180/210
1350	2.5	1100*2100	1950*1500*2450	2600*2350	3200*3700	5200	2200	150
	3.0					5500	3100	150
	3.5					5800	3700	180
	4.0					6200	4000	180/210
1600	2.5	1100*2100	1950*1750*2450	2600*2600	3200*4000	5200	2200	150
	3.0					5500	3100	150
	3.5					5800	3700	180
	4.0					6200	4000	150/210
2000	2.5	1100*2100	2000*1950*2450	2650*2800	3200*4000	5200	2200	150
	3.0					5500	3100	150
	3.5					5800	3700	180
	4.0					6200	4000	150/210

Note:Reference only, for detail information,please contact SUNNY elevator.

SMALL MACHINE ROOM ELEVATOR



Small Machine Room Elevator Construction Sketch

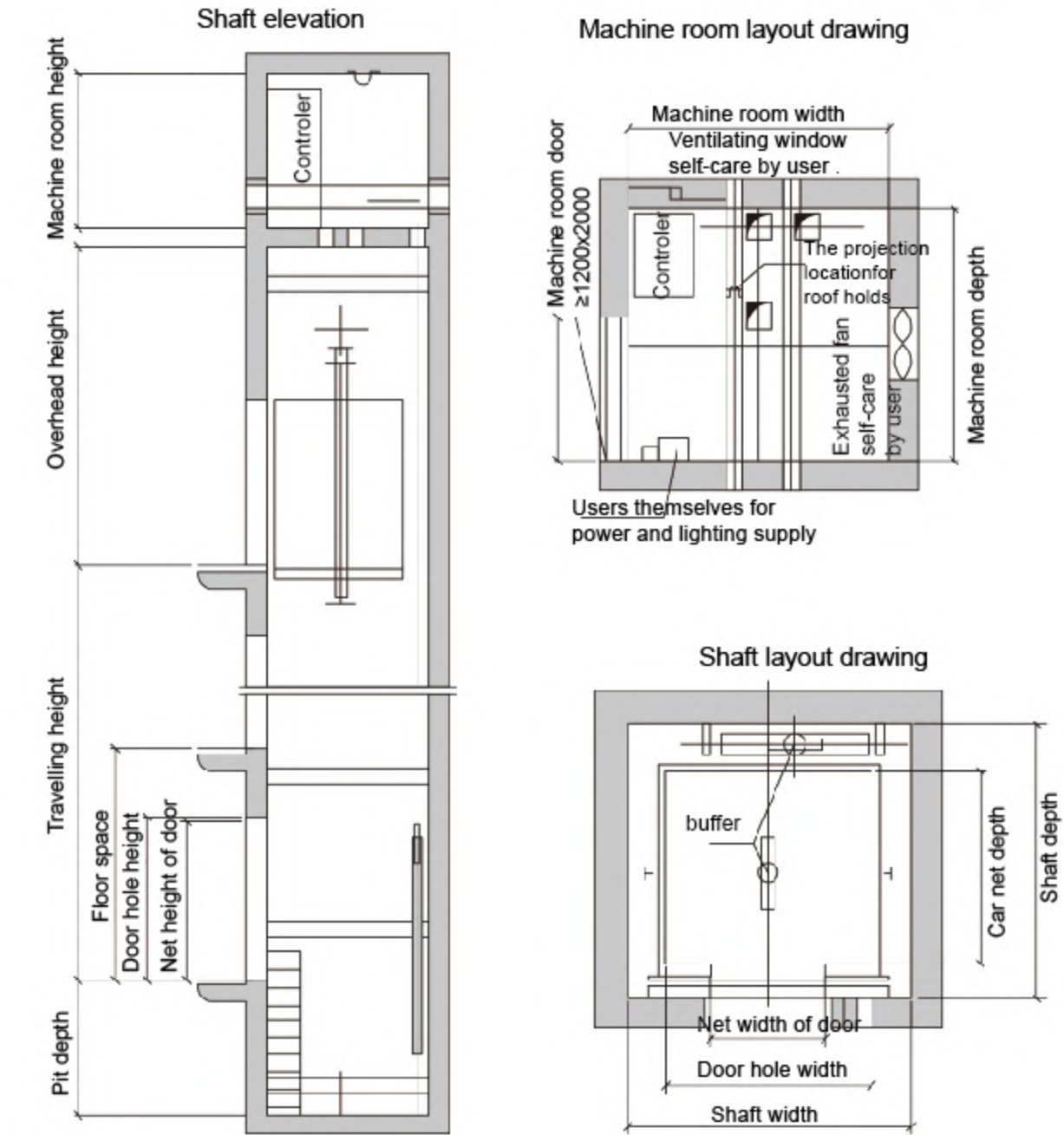

Small machine room elevator parameter table

Persons	Load (kg)	Speed (m/s)	Net size of car(mm)	Net size of door(mm)	Shaft size(mm)			Machine room size(mm)	
			C.WxC.DxD.H	2P Central opening	H.WxH.D	HR.H	PIT	MR.WxMR.D	MR.H
6	450	1.0	1400*850*2300	800*2100	2000*1500	4000	1500	2000*1500	2500
		1.5/1.75				4400			
8	630	1.0	1400*1100*2300	800*2100	2000*1720	4200	1500	2000*1720	2500
		1.5/1.75				4400			
10	800	1.0	1400*1350*2300	800*2100	2000*1970	4200	1500	2000*1970	2500
		1.5/1.75				4400			
		2.0				1800			
		2.5				2000			
		4.0				3850			
13	1000	1.0	1600*1450*2300 1100*2100*2300 (Residence/stretcher elevator)	900*2100	2200*2120 2100*2500 (Residence/stretcher elevator)	4200	1500	2200*2120 2100*2500 (Residence/stretcher elevator)	2500
		1.5/1.75				4400			
		2.0				1800			
		2.5				2000			
		3.0				2600			
		3.5				3100			
		4.0				3850			
		6.0				4300			
16	1250	1.0	1900*1450*2300	1100*2100	2500*2150	4200	1500	2500*2150	2500
		1.5/1.75				4400			
		2.0				1800			
		2.5				2000			
		3.0				2600			
		3.5				3100			
		4.0				3850			
18	1350	1.0	1900*1550*2300	1100*2100	2500*2250	4200	1500	2500*2250	2500
		1.5/1.75				4500			
		2.0				1800			
		2.5				2000			
		3.0				2600			
		3.5				3100			
21	1600	1.0	1900*1800*2300	1100*2100	2500*2500	4200	1500	2500*2500	2500
		1.5/1.75				4500			
		2.0				1800			
		2.5				2000			
		3.0				2600			
		3.5				3100			
		4.0				3850			
26	2000	1.0	1900*1800*2300	1100*2100	2700*2500	6350	4300	2700*2500	2500
		1.5/1.75				4500			
		2.0				1500			
		2.0				4700			

Note: Reference only, for detail information, please contact SUNNY elevator.

It Fulfills Small Cost

Small volume traction machine combines with integrated controller, so that it makes the machine room size same with well size. It covers the equal area as that of the well. At the same time of reducing the machine room height it beautifies the building outlook. It fulfills super small standard of machine room space and building cost.

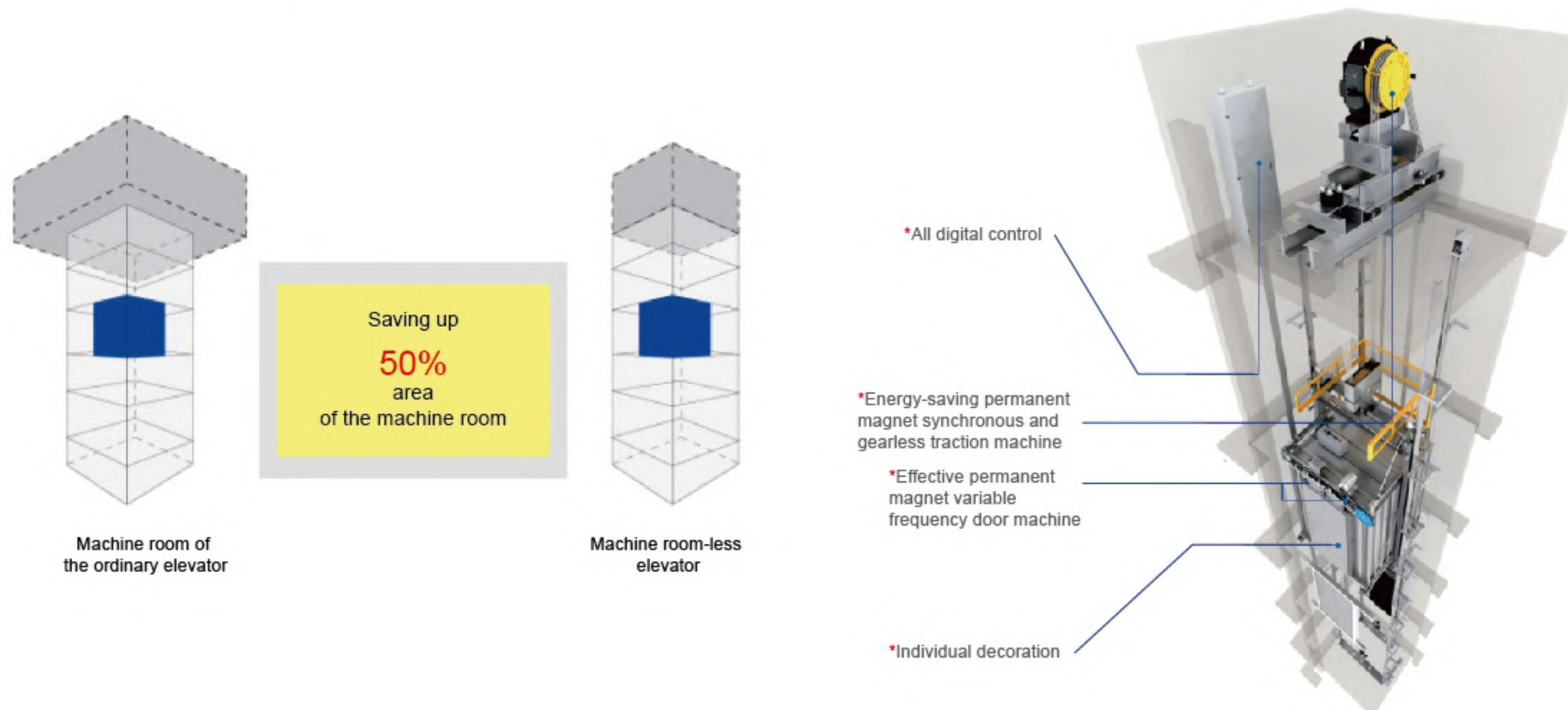

MACHINE ROOM-LESS ELEVATOR



Greatness in Trivialness Intellectual and Outstanding

SUNNY machine room-less elevator series resolves the restriction to the elevator in the construction, building cost, building design style, use range. At the same time of saving the space and cost, it provides the passengers with upper level intellectual, effective and stable travel.

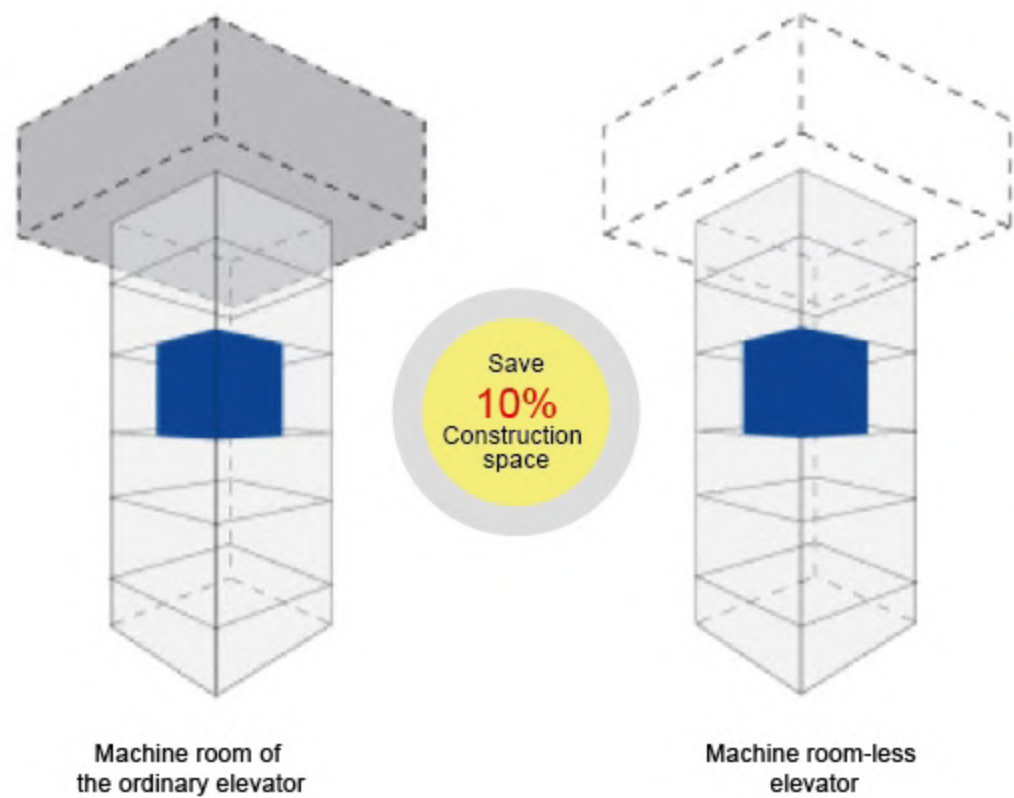

- *Well optimal design has effectively save 10% construction areas.
- *Being equipped with green drive and energy conservation device, energy conservation has reached 30%.
- *Machine roomless concept makes the design of building more free and comfortable.



Machine Room-less Elevator Construction Sketch

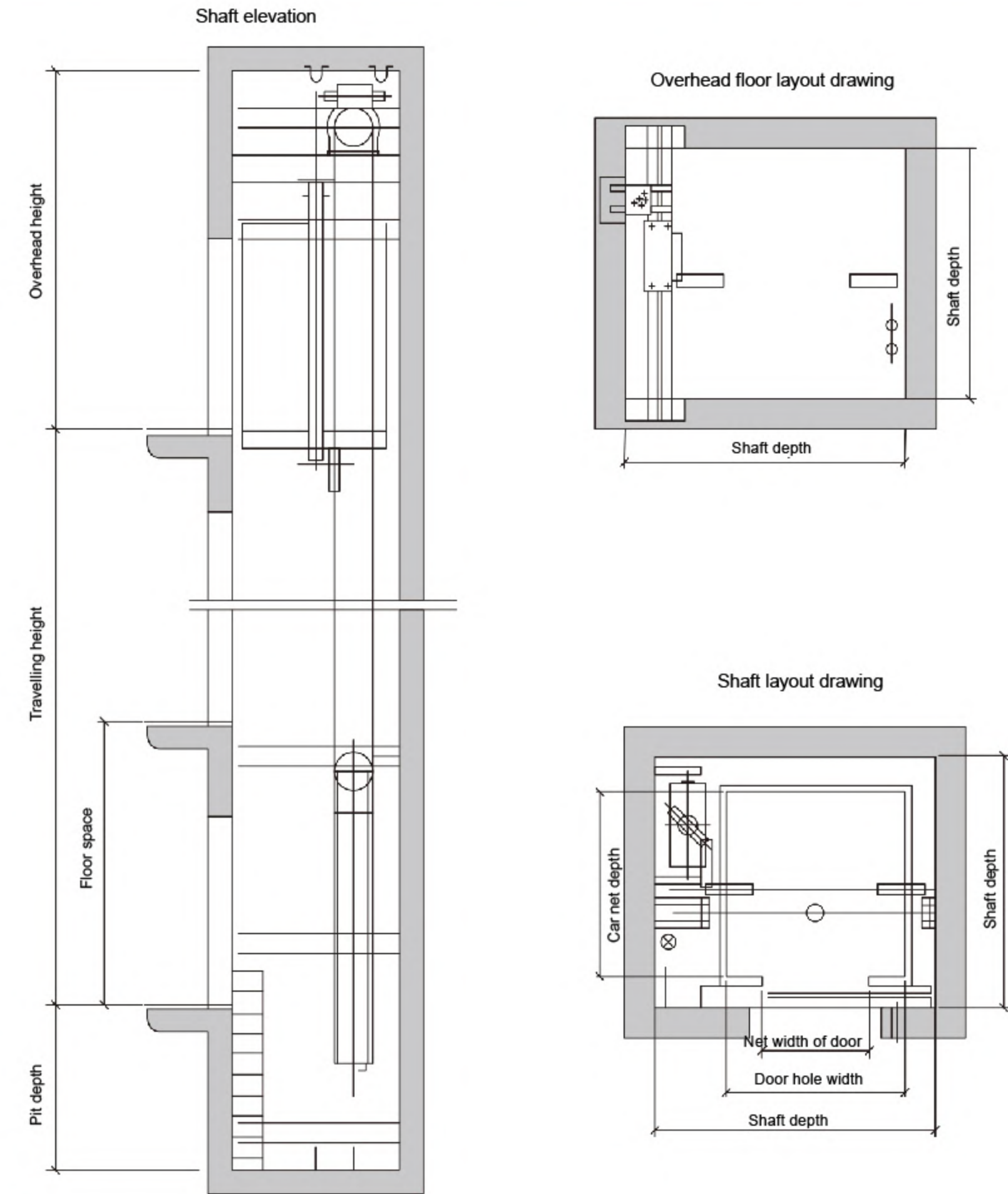

Machine room-less elevator parameter table

Persons	Load (kg)	Speed (m/s)	Net size of car(mm)	Net size of door(mm)	Shaft size(mm)		
			C.WxC.DxD.H	D.WxD.H 2P Central opening	H.WxH.D	HR.H	PIT
6	450	1.0	1100*1100*2300	800*2100	2050*1850	4200	1500
		1.5/1.75					
8	630	1.0	1400*1100*2300	800*2100	2250*1900	4200	1500
		1.5/1.75					
10	800	1.0	1400*1350*2300	800*2100	2250*1950	4200	1500
		1.5/1.75					
		2.0					
		2.5					
		2.0					
13	1000	1.0	1500*1550*2300	900*2100	2350*2150	4200	1500
		1.5/1.75					
		2.0					
		2.5					
21	1600	1.0	1900*1800*2300	1100*2100	2850*2400	4200	1500
		1.5/1.75					
		2.0					
		2.5					
26	2000	1.0	1900*2200*2300	1100*2100	2900*2600	4200	1500
		1.5/1.75					
		2.0					

Note:Reference only, for detail information,please contact SUNNY elevator.

SQUARE OBSERVATION ELEVATOR



Square Observation Elevator Construction Sketch

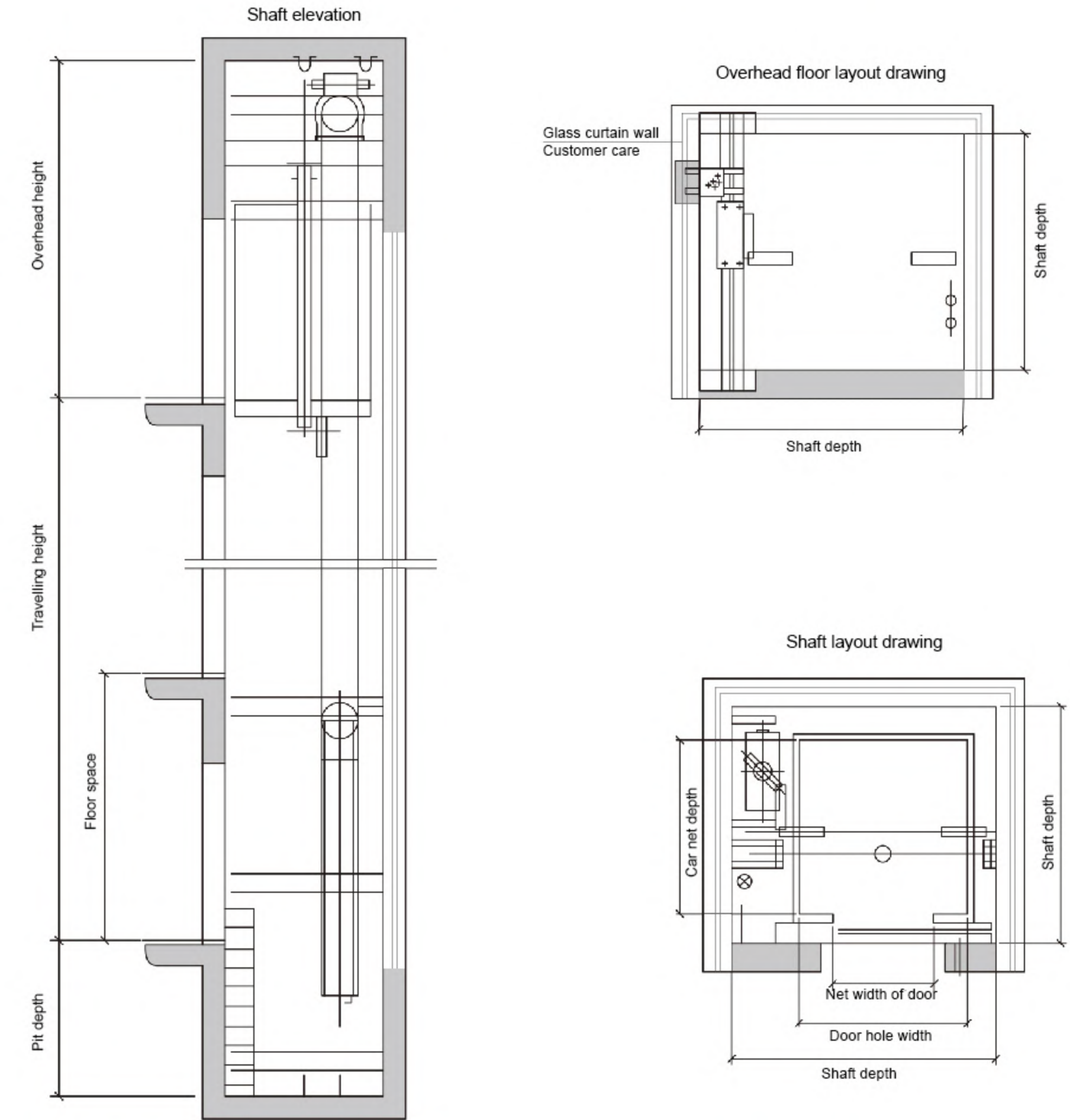

Superior Car Wall

It adopt highly secure safety laminated glass. It is transparent. The passengers might appreciate the busy and prosperous city sight through the transparent car wall. Lamination layer in laminated glass resists radiation. It buffers sound-wave vibration and isolates the sound. Large area car wall glass design shows smooth and beautiful lines. It beautifies the elevator car outline. Furthermore, the buildings are attractive.



Super large viewing field

Full transparent lift car design can maximize the field of view. Through the visual extension, passengers can have a panoramic view of all the beautiful scenery.

Multiple lift car shapes

Round, square and rhombic and other lift car shapes are optional, perfectly corresponding to different architectural styles.

Square machine room/machine roomless elevator parameter table

Persons	Load (kg)	Speed (m/s)	Net size of car(mm)	Net size of door(mm) D.WxD.H	Shaft size(mm)		
			C.WxC.DxD.H	2P Central opening	H.WxH.D	HR.H	PIT
6	450	1.0	1100*1100*2300	800*2100	2050*1850	4200	1500
8	630	1.0	1400*1100*2300	800*2100	2250*1900	4200	1500
		1.5/1.75				4400	1600
10	800	1.0	1400*1350*2300	800*2100	2250*1950	4200	1500
		1.5/1.75				4400	1600
		2.0				4800	1800
		2.5				4800	2000
13	1000	1.0	1500*1550*2300	900*2100	2350*2150	4200	1500
		1.5/1.75				4400	1600
		2.0				4800	1800
		2.5				4800	2000
21	1600	1.0	1900*1800*2300	1100*2100	2850*2400	4500	1500
		1.5/1.75				4700	1600
		2.0				4900	1800
		2.5				5100	2000
26	2000	1.0	1900*2200*2300	1100*2100	2900*2600	4500	1500
		1.5/1.75				4700	1600
		2.0				4900	1800

Note: Reference only, for detail information, please contact SUNNY elevator.

SEMICIRCLE OBSERVATION ELEVATOR



Outer Glass Hood

It harmoniously combines with the building and surrounding. Panoramic elevator is part of the building. It also adds a mobile charming scene for the building.

Outstanding sound insulation

The structure of the lift car is further optimized, which facilitates the elevator to achieve excellent sound insulation effect and customers to have quiet and steady using experience.

Diversified decoration design

There are a series of optional materials and colors for hoistway doors, handles and lift car walls, thus truly realizing individualized customized services.



Semicircle Observation Elevator Construction Sketch

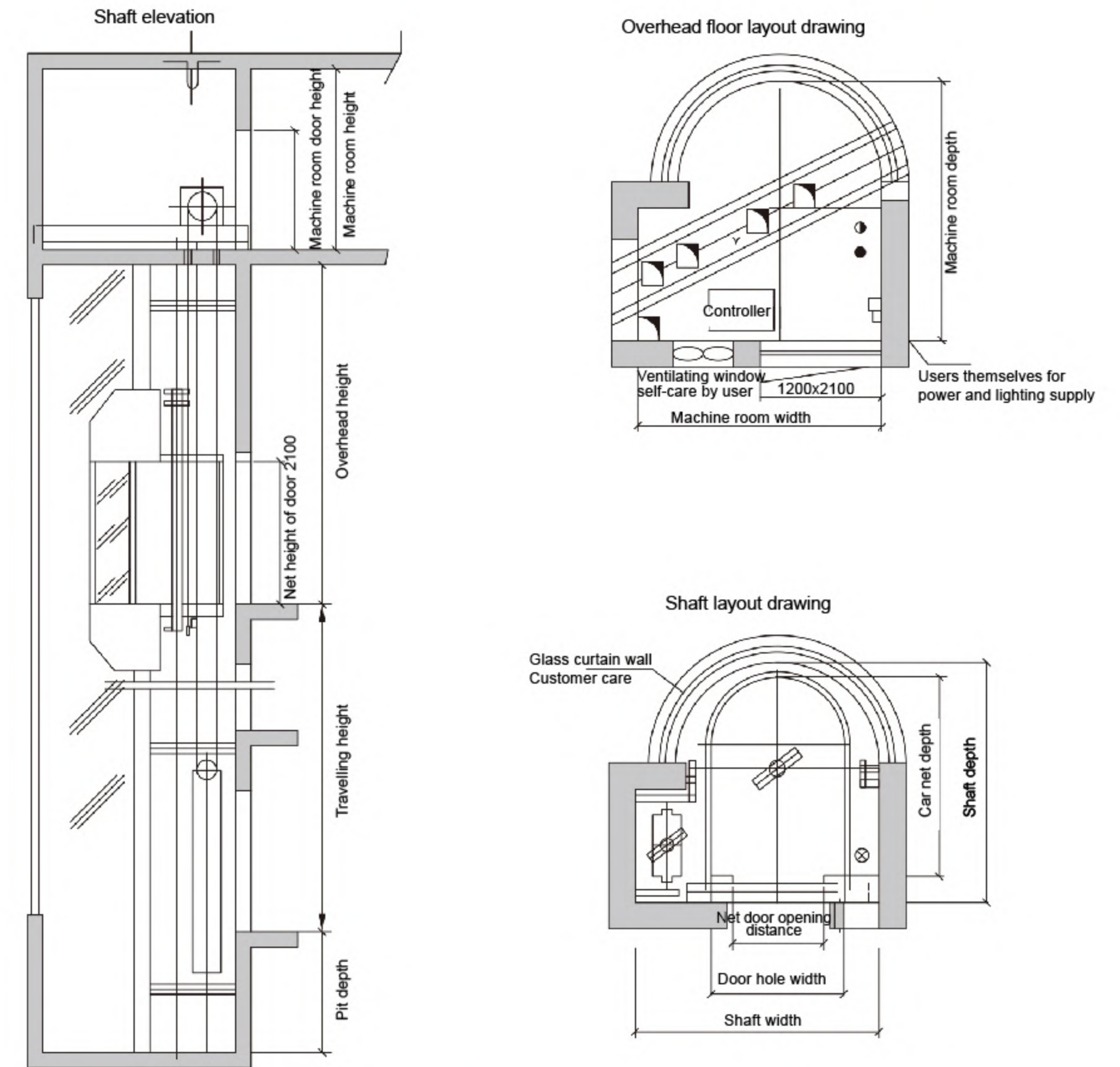

Semicircle machine room/machine roomless elevator parameter table

Persons	Load (kg)	Speed (m/s)	Net size of car(mm)		Shaft size(mm)			Machine room size(mm)	
			C.WxC.DxD.H	2P Central opening	H.WxH.D	HR.H	PIT	MR.WxMR.D	MR.H
8	630	1.0	1100*1600*2300	700*2100	2200*2185	4500	1500	2200*2185	2500
		1.5/1.75				4700	1600		
10	800	1.0	1200*1800*2300	800*2100	2300*2355	4500	1500	2300*2355	2500
		1.5/1.75				4700	1600		
		2.0				4900	1800		
		2.5				5100	2000		
13	1000	1.0	1300*1950*2300	900*2100	2400*2535	4500	1500	2400*2535	2500
		1.5/1.75				4700	1600		
		2.0				4900	1800		
		2.5				5100	2000		
16	1250	1.0	1400*2150*2300	900*2100	2500*2600	4500	1500	2500*2600	2500
		1.5/1.75				4700	1600		
		2.0				4900	1800		
		2.5				5100	2000		
18	1350	1.0	1500*2150*2300	1000*2100	2600*2600	4500	1500	2600*2600	2500
		1.5/1.75				4700	1600		
		2.0				4900	1800		
		2.5				5100	2000		
21	1600	1.0	1500*2450*2300	1000*2100	2600*2900	4500	1500	2600*2900	2500
		1.5/1.75				4700	1600		
		2.0				4900	1800		
		2.5				5100	2000		
26	2000	1.0	1700*2600*2300	1100*2100	2800*3050	4500	1500	2800*3050	2500
		1.5/1.75				4700	1600		
		2.0				4900	1800		

Note: Reference only, for detail information, please contact SUNNY elevator.

HOSPITAL ELEVATOR



Hospital Elevator Construction Sketch

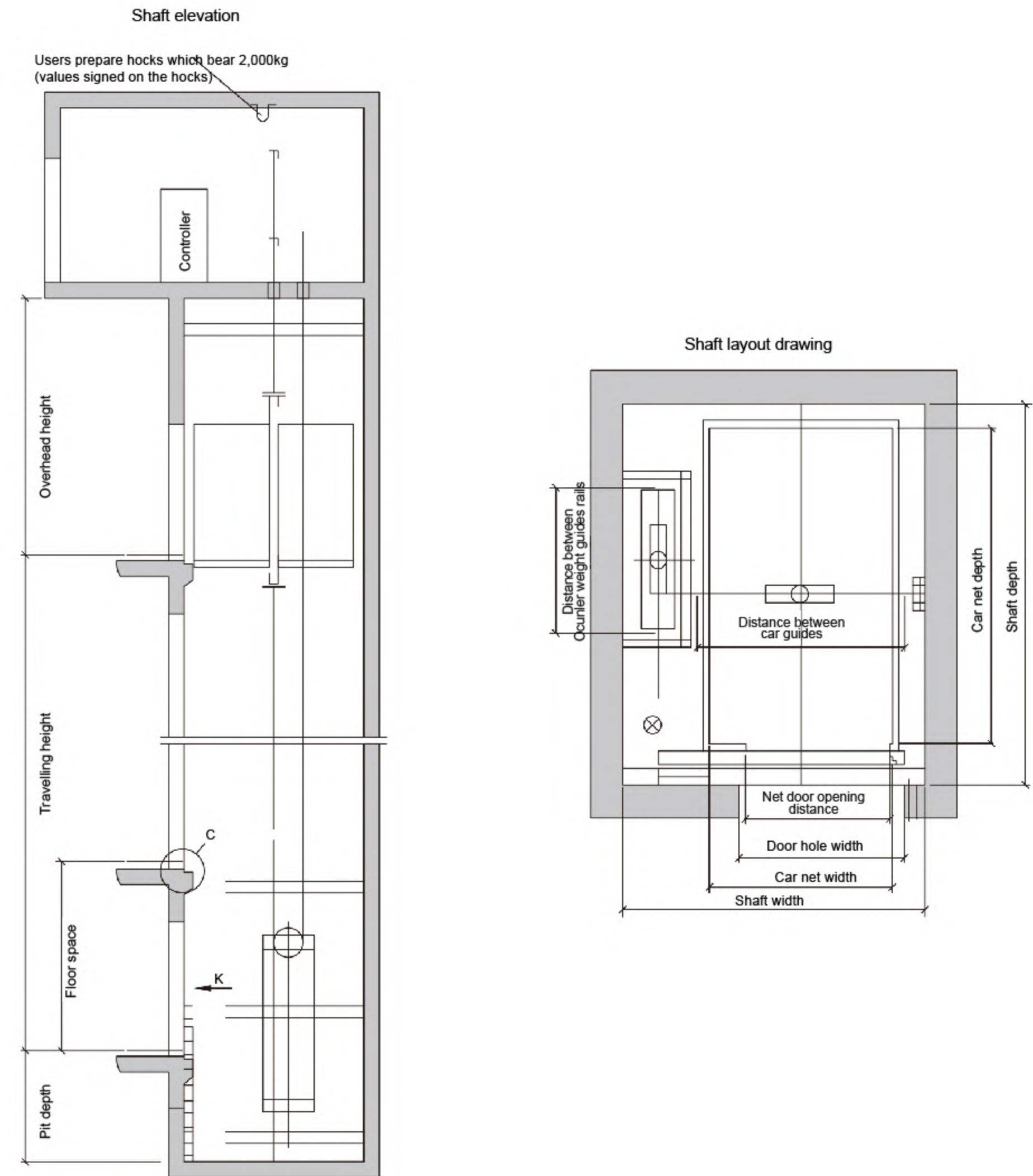

Warm Concern A Beautiful Humanity World

SUNNY hospital elevators are not just used in delivering passengers. Because of its use particularity, it has special and strict requirements to the elevator use properties. SUNNY hospital elevator can accurately control the elevators' running speed. It brings about the smooth and comfortable travel.

SUNNY hospital elevator lays special importance upon the humane design. It fully optimizes the car structure. It satisfies the clients' use requirements to the greatest extent. It creates a peaceful and graceful space for vast passengers.

SUNNY hospital elevator satisfies the needs of emergency patients' delivery. It applies humanization design and is equipped with a full set of top equipments. It is smooth and comfortable in running.

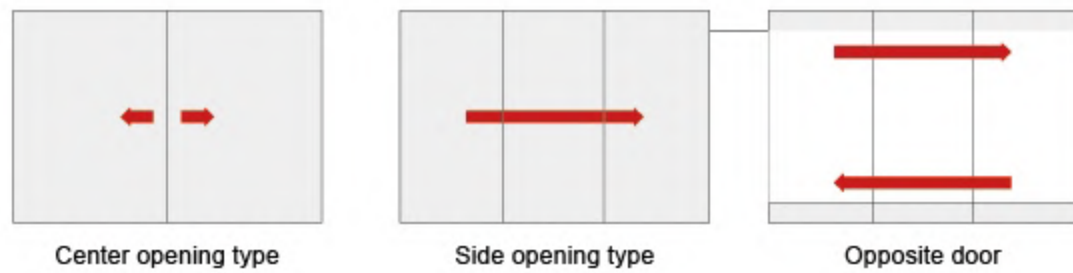

Hospital elevator parameter table

Persons	Load (kg)	Speed (m/s)	Net size of car(mm)	Net size of door(mm)	Shaft size(mm)			Machine room size(mm)	
			C.WxC.DxD.H	D.WxD.H	H.WxH.D	HR.H	PIT	MR.WxMR.D	MR.H
21	1600	1.0	1400*2400*2300	1100*2100	2550*2900	4500	1500	2550*2900	2500
		1.5/1.75				4700	1600		
		2.0				4900	1800		
		2.5				5100	2000		
24	1800	1.0	1600*2400*2300	1200*2100	2750*2900	4500	1500	2750*2900	2500
		1.5/1.75				4700	1600		
		2.0				4900	1800		
		2.5				5100	2000		
26	2000	1.0	1700*2400*2300	1200*2100	2850*2900	4500	1500	2850*2900	2500
		1.5/1.75				4700	1600		
		2.0				4900	1800		
		2.5				5100	2000		

Note: Reference only, for detail information, please contact SUNNY elevator.

HOME ELEVATOR



✔ Your Perfect Life is Comfortable and Relaxing

The humanization design decorates your noble life space. We enhance your life grade in the times of high & new tech. SUNNY home elevator brings about a more convenient and high-grade life.

It displays the outstanding properties in a limited space. It has no machine room. Extremely small top-floor height can match with various old and new residences. Relying on the standard track installation system, the elevator can be installed more quickly and conveniently. In addition, the smooth start and leveling system bring about the rare stable elevator operation. Therefore you feel more comfortable in the elevator travel.



✔ The Characteristics of Home Elevator

*No need of traditional machine room, without any construction cost increased. Specially designed rucksack frame for the home elevator with traction ratio 2:1 VVVF drive technology, SUUNY home elevator appropriate micro processing control.

*Slide + roller composite guide shoe.

*The appropriate traction machine bracker is fixed on the guide rail.

The building will not have any load.

*We apply 220V single-phase home elevator special machine.

*Automatic special door machine, synchronous timing belt transmission, TUV CE Certification passed.

*Comply with home elevator national standard GB/T21739-2008.

Home Elevator Construction Sketch

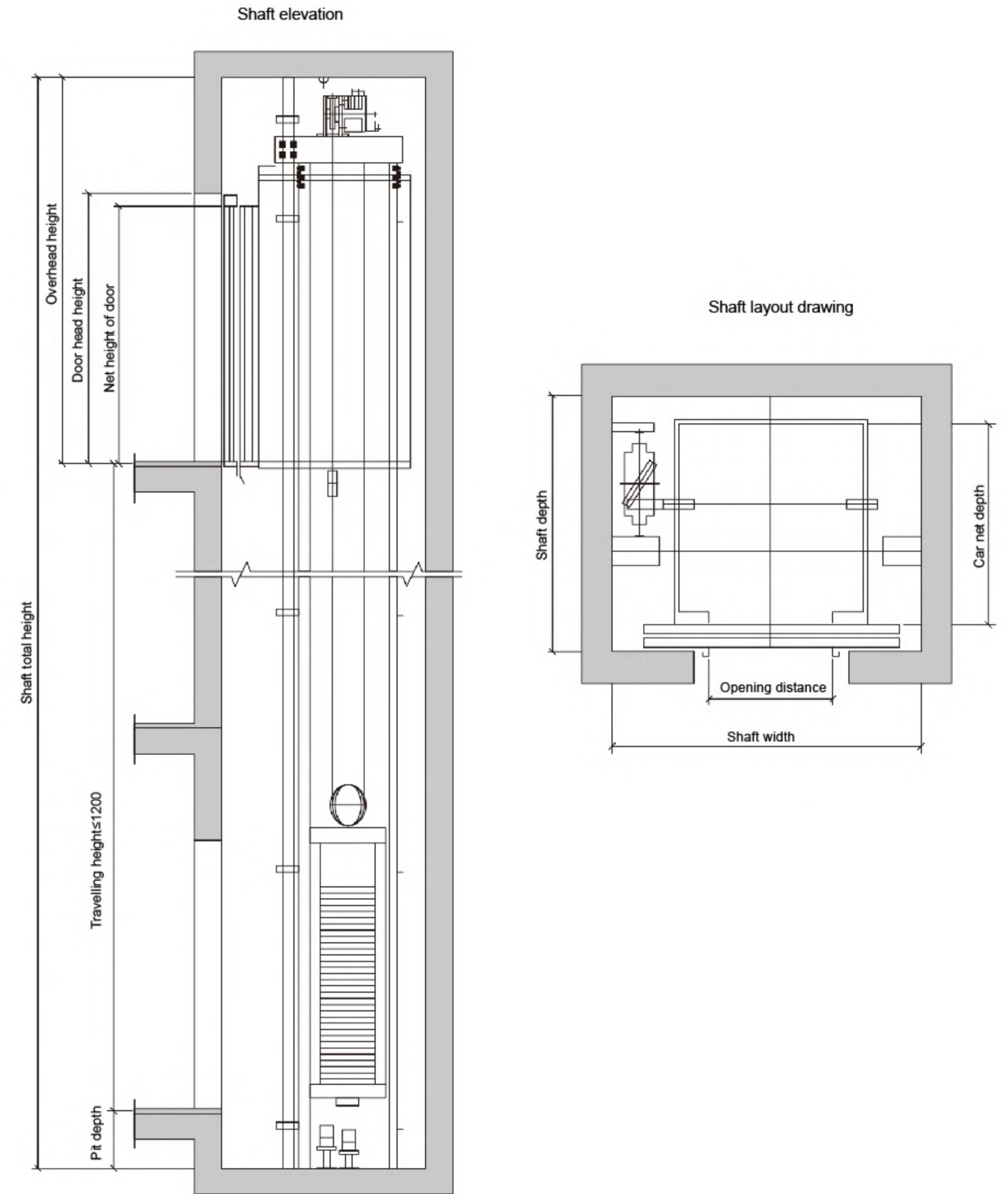



Home elevator parameter table



Persons	Load (kg)	Speed (m/s)	Net size of car(mm)	Net size of door(mm) D.WxD.H	Shaft size(mm)		
			C.WxC.DxD.H	2P Central opening	H.WxH.D	HR.H	PIT
3	260	0.4	800*1150*2200	700*2000 Side door	1400*1500	3500	800
4	320	0.4	950*1300*2200	700*2000	1600*1600	3500	800
5	400	0.4	1200*1300*2200	800*2000	1850*1600	3500	800

Note: Reference only, for detail information, please contact SUNNY elevator.





PERFECT FUNCTION

★ Standard Function

 Travel Function	VVVF drive	Motor rotating speed can be precisely adjusted to get smooth speed curve in lift start, travel and stop and gain the sound comfort.
	VVVF door operate	Motor rotating speed can be precisely adjusted to get the more gentle and sensitive door machine start/stop.
	Independent running	The lift can not respond to outer calling, but only respond to the command inside the car through the action switch.
	Automatic pass without stop	When the car is crowded with the passengers or the load is otiose to ppreset value, the car will automatically pass the calling landing in order to keep maximum travel efficiency.
	Automatically adjust door opening time	Door-open time can automatically adjusted according to the difference between landing calling or car calling
	Reopen with hall call	In the door shutting process, press reopen with hall callbutton can restart the door.
	Express door closing	When the lift stops and opens the door, press door-shut button, the door will be closed immedeiatly.
	Car stops and door open	The lift decelerates and levels, the door only opens after the lift comes to a complete stop.
	Command register cancel	If you press the wrong floor command button in the car,twice continuous pressing of same button can cancel the register.
 Safety Function	Photocell protection	In the door open and shut period, infrared light that covers the whole door height is used to probe the door protection device of both the passengers and objects.
	Designated stop	If the lift can not open the door in the destination floor out of some reason, the lift will close the door and travel to the next designated floor.
	Overload holding stop	When the car is overload, the buzzer rings and stops the lift in the same floor.
	Anti-stall timer protection	The lift slops operation due to slippery traction wire rope.
	Start protection control	If the lift does not leave door zone within the designated time after it gets started, it will stop the operation.
	Inspection operation	When the lift enters into inspection operation, the car travels at inching running.
	Fault self-diagnosis	The controller can record 62 latest troubles so as to quickly remove the trouble and restore the lift operation.
	Repeated door closing	If the lift can not close the door due to certain obstacle or interference, the lift will reopen, or re-shut the door until sundries are eliminated.
	Up/down aver-run and final limit protection	The device can effectively prevent from the lift's surging to the top or knocking the bottom when it is out of the control.It results in the more safe and reliable lift travel.
	Down over-speed protection device	When the elevator downs 1.2 times higher than the rated speed. This device will automatically cut off control power. stop the motor running so as to stop lift down at over-speed. If the lift continues to down at over-speed, and the speed is 1.4 times higher than rated speed, safety tongs act to force the lift stop in order to ensure the safety.
Upward over-speed protection device	When the lift ups 1.2 times higher than rated speed,the device will automatically decelerate to brake the lift.	
 Man-machine Interface	Micro-touch button for car call and hall call	Novel micro-touch button is used for operation panel command button in the car and landing calling button.
	Floor and direction indicator car	The car shows the lift floor location and current travel direction.
	Floor and direction indicator	The landing panel shows the lift floor location and current travel direction.

 Emergency Function	Emergency car lighting	Emergency car lighting automatically activated when there is power failure.
	Inching running	When the elevator enters into emergency electric operation. the car travels at low speed inching running.
	Five way intercom	Communication amid car, car top, elevator machine room. well pit and rescue duty room through walkie-talkie.
	Bell	In emergency conditions. if bell button above car operation panel is continuously pressed. electric bell rings on top of he car.
	Fire emergency return	If you start key switch in main landing or monitor screen. all the callings will be cancelled. The elevator directly and immediately drives to the designated rescue landing and automatically opens the door.
 Energy-saving Function	Car ventilation, light automatic shut off	If there is no calling or command signal within the stipulated time. the car fan and lighting will be automatically closed in order to save the energy.
	Remote shut-off	The elevator can be called to main landing (after finishing the service) through the key switch and automatically exists the service.

★ Optional Function

 Emergency Function	Leveling when power failure	In normal power failure. the chargeable battery supplies the elevator to power. The elevator drives to the nearest landing.
 Travel Function	Anti-nuisance	In the light elevator load. when three more commands appear. in order to avoid the unnecessary parking, all the registered callings in the car will be cancelled.
	Open the door in advance	When the elevator decelerates and enters into door open zone. it automatically opens the door to enhance the travel efficiency.
	Direct parking	It completely accords with distance principle with no crawling in the leveling. It greatly enhances the travel efficiency.
	Group control function	When three or more same model lift groups are controlled in use, the lift group can automatically choose the most appropriate response. It avoids the repeated lift parking, reduces the passengers' waiting time and increases the travel efficiency.
	Duplex control	Two sets of same model elevators can unanimously respond the calling signal through the computer dispatch. In this way. it reduces the passengers' waiting time to the greatest extent and enhances the travel efficiency as well.
	On-duty peak service	Within the preset on-duty time,upward transport from the home landing is extremely busy. The lifts are continuously dispatched to the home landing in order to satisfy on-duty peak service.
	Off-duty peak service	Within the preset off-duty period, the lifts are continuously dispatched to top floor in order to satisfy off-duty peak service.
	Door open time extending	Press special button in the car, the lift door keeps open for certain period of time.
	Car arrival gong	Arrival tong in the car top announces that the passengers arrive.
	 Man-machine Interface	Voice announcer
Car assistant operation box		It is used in the large loading weight lifts or the elevators with crowded passengers so that more and more passengers can use the car.
Operation box for the handicapped		It is convenient for the wheelchair passengers and those who have vision problems.
Intelligent calling service		The car command or hoist- way calling can be locked or connected through special Intelligent Input.
IC card control function		All(partial) landings can only input car commands through IC card after authorization.
 Monitor Function	Remote monitor	The elevator long - distance monitor and control can be fulfilled through modem and telephone. It is convenient for the factories and service units to timely know the travel conditions of every elevator and promptly take the corresponding measures.
	Remote control	The life car have independent travel according to the specific requirements through operation monitor screen(optional).
	Camera function in the car	The camera is installed in the car to monitor the car conditions.

STANDARD CONFIGURATION



GE-CD-106 Standard

Stainless steel car

Ceiling: GE-CC-509 style, arched top-plate, bright lighting

Car wall: Hairline stainless steel

Operation panel: GE-COP-010

Car door: Hairline stainless steel, center opening

Floor: GE-CF-601

Operation panel



GE-COP-010

Landing door



GE-DP-321



GE-DP-318



GE-DP-395

Ceiling



GE-CC-509
Arched top-plate, bright lighting



GE-CC-537
Central LED luminous panel,
LED down lamps on both sides

Floor



GE-CF-601

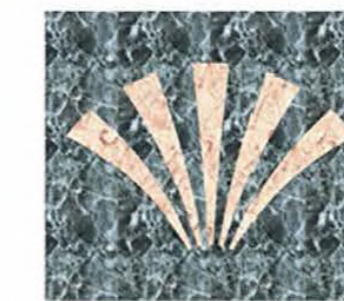

GE-CF-603

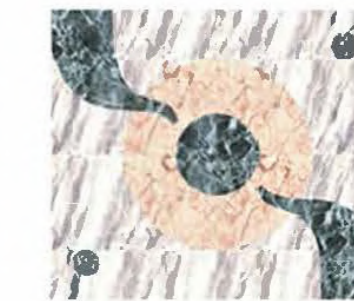

GE-CF-604

Outbound call



GE-LOP-010



GE-LOP-010B

PASSENGER ELEVATOR CAR DECORATION

-ECONOMIC SERIES



GE-CD-108 Economic Solution

Ceiling: St.St frame with milk white acrylic lighting deco two sides.
 Middle Panel: Mirror, Etching.
 Side Panel: Hairline.
 Handrail model: GE-CH-701



GE-CD-129



GE-CD-131



GE-CD-142



GE-CD-115

Ceiling: St.St frame with white acrylic lighting panel.
 Middle Panel: Mirror.
 Side Panel: Mirror, Etching.
 Handrail model: SN-CH-711

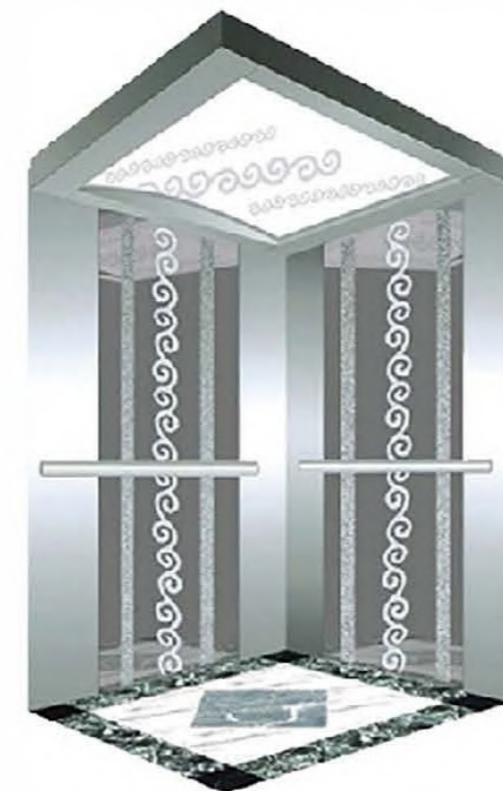

GE-CD-118

Ceiling: St.St frame with white acrylic lighting panel.
 Middle Panel: Mirror, Etching.
 Side Panel: Hairline.
 Handrail model: SN-CH-701

GE-CD-107

Ceiling: St.St frame with multi-layer lighting board, acrylic lighting deco.
 Middle Panel: Mirror, Etching.
 Side Panel: Hairline.
 Handrail model: SN-CH-701



GE-CD-146



GE-CD-150



GE-CD-155



GE-CD-164



GE-CD-168



GE-CD-303

PASSENGER ELEVATOR CAR DECORATION

-MODERN SERIES



GE-CD-113 Modern Solution

Ceiling: St.St frame with white acrylic lighting panel.
 Middle Panel: Mirror, Hairline, Etching.
 Side Panel: Mirror.



GE-CD-153



GE-CD-429



GE-CD-432



GE-CD-433



GE-CD-434



GE-CD-435



GE-CD-436



GE-CD-K106



GE-CD-K107



GE-CD-110

Ceiling: St.St frame with white acrylic lighting panel.
 Middle Panel: Mirror, Etching.
 Side Panel: Pasted Wooden Deco.
 Handrail model: SN-CH-709



GE-CD-112

Ceiling: St.St frame with white painted acrylic lighting panel.
 Middle Panel: Mirror, Etching.
 Side Panel: Mirror.

GE-CD-109

Ceiling: St.St frame with green white acrylic lighting panel.
 Middle Panel: Mirror, Etching, Hairline, Concave Green.
 Side Panel: Mirror, Etching, Hairline, Concave Green.

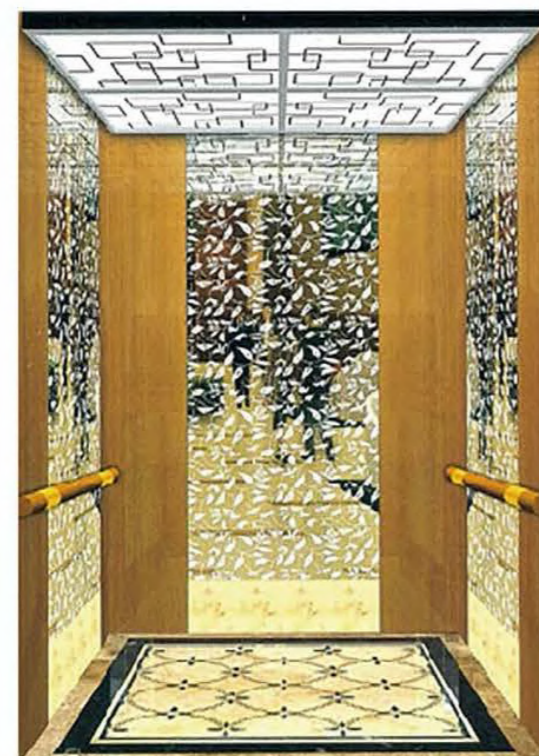

PASSENGER ELEVATOR CAR DECORATION

-LUXURY SERIES

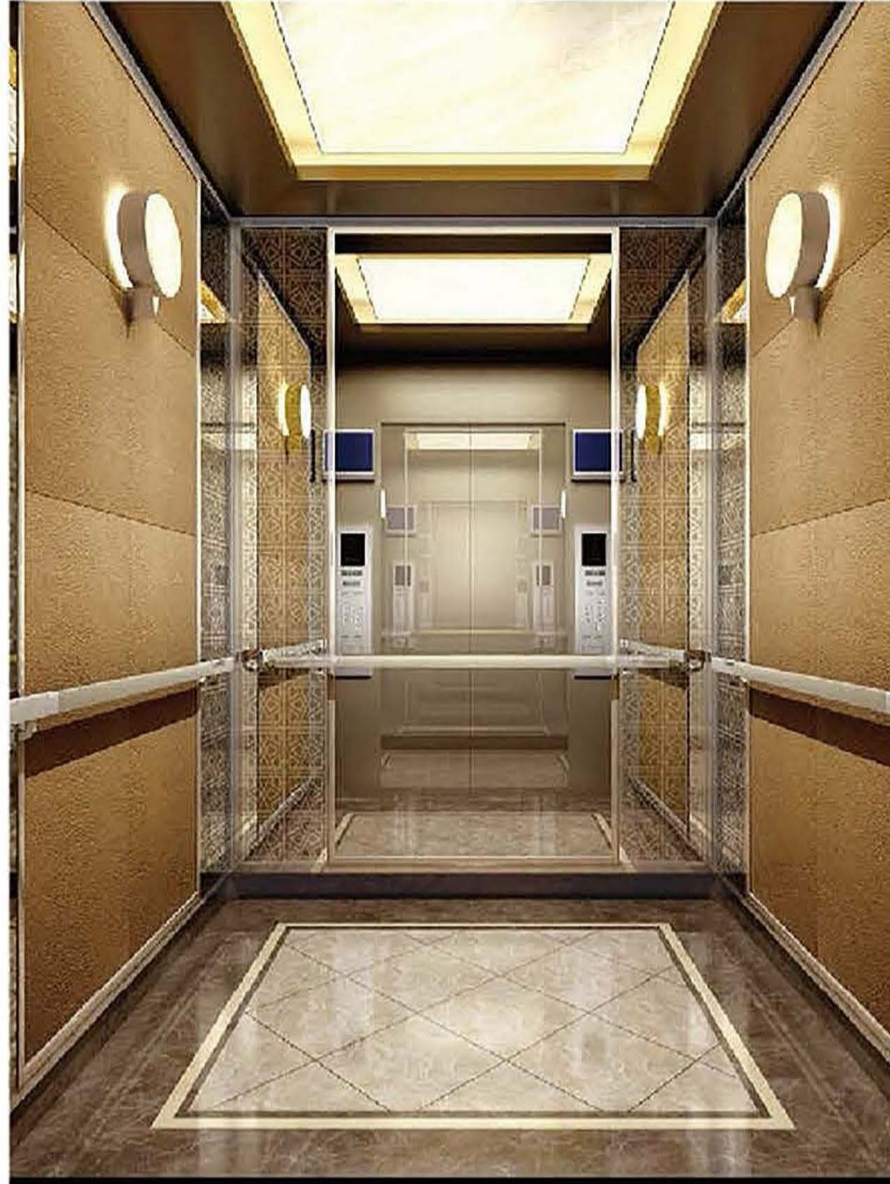

GE-CD-407 Luxury Solution

Condole top: Mirror stainless steel border, medium is white organic transparent board

Center plate: leather soft bag

Auxiliary plate: mirror, etch, stainless steel

Handrail: organic glass armrest

Floor: 2mmPVC spline.(optional marble)



GE-CD-411



GE-CD-413

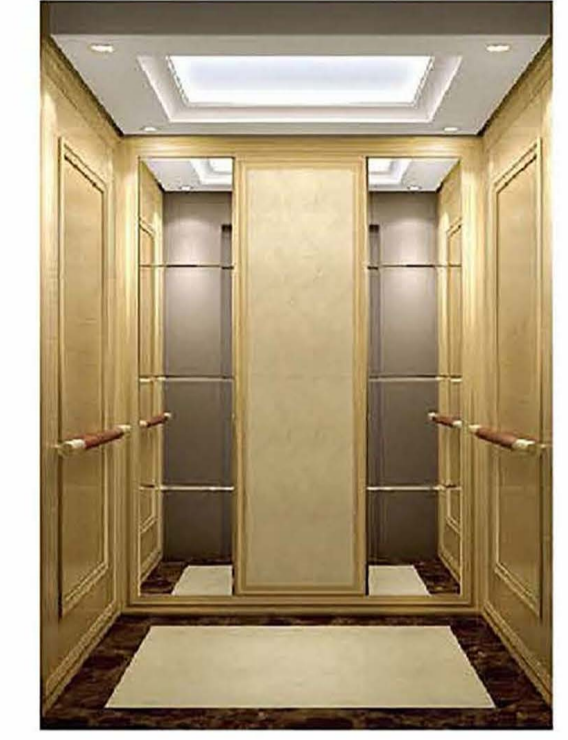

GE-CD-414



GE-CD-409

Condole top: four sides wooden adornment frame, middle mirror titanium, concealed light, LED illum.

Center board: leather soft bag, wood decoration

Auxiliary board: Center of the mirror titanium, surrounding wood decorative frame

Handrail: titanium garden handrail



GE-CD-410

Condole top: wooden condole top border, tube lamp illum

Back wall: Wood veneer, advertising frame, mirror stainless steel

(self-care of advertising drawing customers)

Side wall: wood decoration, cloth art

Handrail: stainless steel leather armrest



GE-CD-415

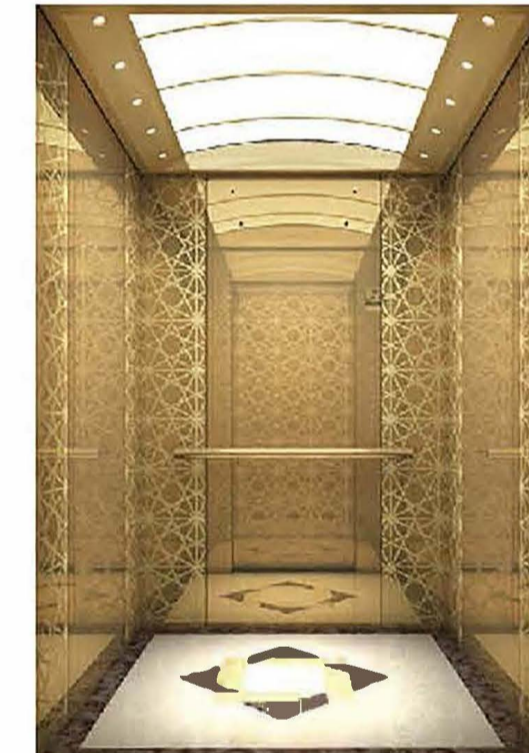

GE-CD-419

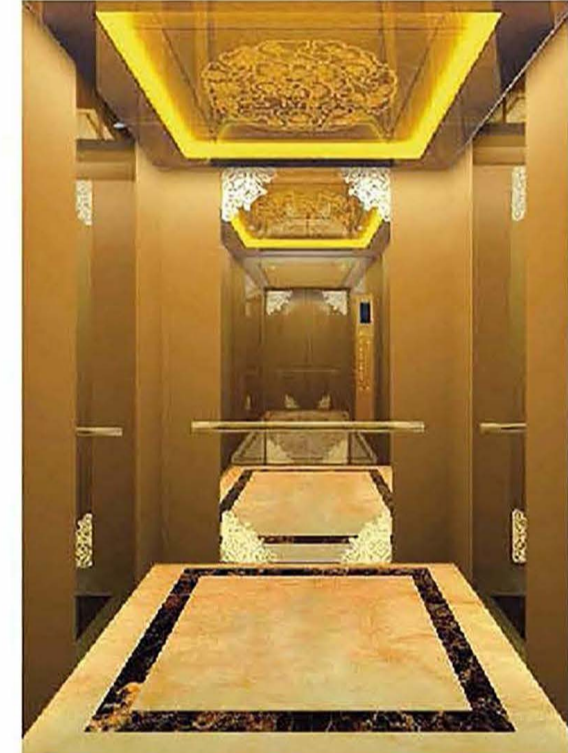

GE-CD-421

GE-CD-400

Ceiling: titanium mirror stainless steel, common roof, lamp lighting

Center plate: mirror, and grain, titanium

Auxiliary board: mirror, and grain, titanium

Handrail: wood and titanium combination round tube handrail

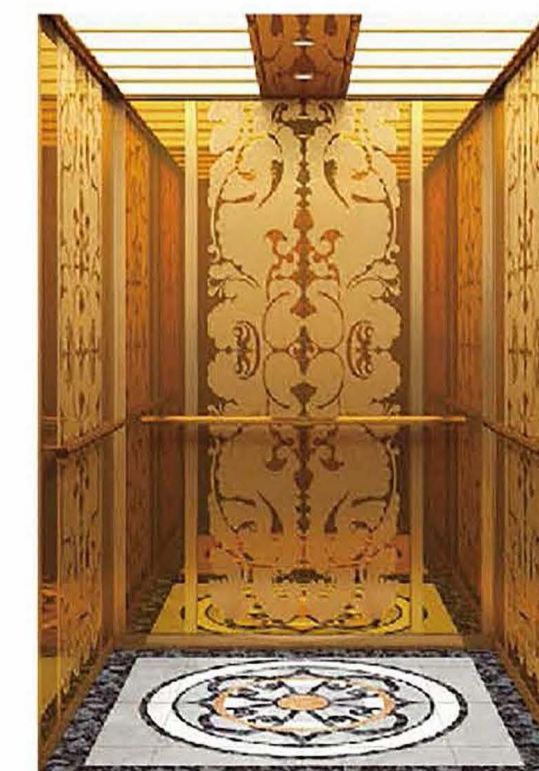

GE-CD-422

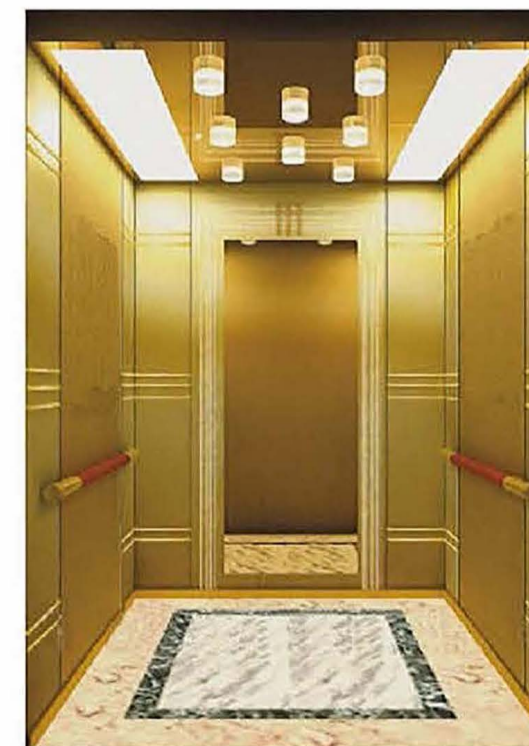

GE-CD-441



GE-CD-442



PANORAMIC ELEVATOR CAR DECORATION



GE-CD-912 Economic Solution

Upper and lower cover: Steel plate spraying
 Sightseeing wall: Safety clip glass Decorative top: HM-427 ceiling
 Cage wall: Safety clip glass
 Handrail: Stainless steel plate
 Floor: PVC floor



ECONOMIC SERIES



GE-CD-902

Upper&Bottom Canopy: Hairline
 Viewing Glass: Laminated Glass(2LAYERS)
 Cabin Wall: Hairline St./St
 Handrail: St./St. Tube
 Floor: PVC



GE-CD-910

Upper & Bottom Canopy: Hairline with Light Deco
 Viewing Glass: Laminated Glass(2 Layears)
 Cabin Wall: Hairline St./St
 Handrail: St./St. Tube
 Floor: PVC

GE-CD-901

Upper&Bottom Canopy: Hairline
 Viewing Glass: Laminated Glass(2Layers)
 Cabin Wall: Hairline St./St
 Handrail: St./St. Tube
 Floor: PVC



GE-CD-313

Upper and lower cover: Steel plate spraying with acrylic decorative strip
 Sightseeing wall: Three pieces of safety glue glass
 Decorative top: Image board and the lantern on both sides
 Cage wall: Stainless steel plate
 Handrail: Stainless steel double pipe
 Floor: PVC floor



GE-CD-966

Upper & Bottom Canopy: Baked Enamel
 Viewing Glass: Laminated Glass(3Pcs)
 Cabin Wall: Hairline Etching Etching St./St
 Handrail: St./St. Tube
 Floor: PVC



GE-CD-314

Upper and lower cover: Steel plate spraying
 Sightseeing wall: Three pieces of safety glue glass
 Decorative top: Image board and the lantern on both sides
 Cage wall: Stainless steel plate
 Handrail: Stainless steel double pipe
 Floor: PVC floor

PANORAMIC ELEVATOR CAR DECORATION

GE-CD-940 Modern Solution

Center plate: Mirror, stone relief,
titanium

Auxiliary board: Wood grain relief



MODERN SERIES



GE-CD-934

Center plate: Hairline , etching



GE-CD-945

Upper & Bottom Canopy: Steel
paint,Lighting
Viewing Glass: Sandwiced glass
Decorative top:Steel paint,Acrylic
roof,Lighting
Cabin Wall: Stainless steel process tube
Handrail: Stainless steel tube
Floor: PVC

GE-CD-941

Upper & Bottom Canopy: Baked
Enamel
Viewing Glass: Laminated
Glass(3Pcs)
Cabin Wall: Hairline Etching St./St
Handrail: St./St. Tube
Floor: PVC



GE-CD-980

Upper and lower cover: Ladder
pentagon steel paint and decorative
lights
Sightseeing wall: Safety laminated glass
Decorative top: Middle round acrylic top
lamp,Simple lights on both sides
Cage wall: Stainless steel hair plate
Handrail: Single stainless steel tube
Floor: PVC floor



GE-CD-933

Upper & Bottom Canopy:
Semicircular Acrylic Crown with
Metal Cover and Steel Plate
Spraying Coaming
Viewing Glass: Laminated
Glass(3Pcs)
Cabin Wall: Stainless steel hairline
Handrail: Stainless steel double
tube
Floor: PVC



GE-CD-981

Upper and lower cover: Steel plate
spraying
Sightseeing wall: Three pieces of
safety glue glass
Decorative top: Multi-layer reflective
process board plus simple light
Cage wall: Stainless steel hairline
Handrail: Stainless steel single tube
Floor: PVC floor



PANORAMIC ELEVATOR CAR DECORATION



GE-CD-961 *Luxury Solution*

Upper&Bottom Canopy: Bakcd Enamel with Light Deco

Viewing Glass: Laminated Glass(3Pcs)

Cabin Wall: Golden Mirror Etching St./St

Handrail: St./St. Tube

Floor: PVC

LUXURY SERIES



GE-CD-963

Upper&Bottom Canopy: Hairline Round

Viewing Glass: Laminated Glass(3Pcs)

Cabin Wall: Mlrror Etching St./St

Handrail: St./St. Tube

Floor: PVC



GE-CD-964

Upper&Bottom Canopy: Baked Enamel with Light Deco

Viewing Glass: Laminated Glass(3Pcs)

Cabin Wall: Golden Mirror Etching St./St

Handrail: St./St. Tube

Floor: PVC

GE-CD-962

Upper&Bottom Canopy: Half Round Baked Enamel with Acrylic Cop. light Deco

Viewing Glass: Laminated Glass(3Pcs)

Cabin Wall: MIRROR Etching St./St

Handrail: St./St. Tube

Floor: PVC



GE-CD-978

Upper and lower cover: Semicircle acrylic crown and stainless steel coaming

Sightseeing wall: Three pieces of safety glue

Decorative top: Multi-layer reflective process board with tube lamp

Cage wall: Mirror, hair, etching, and grain

Floor: PVC floor



GE-CD-976

Upper and lower cover: Terraced round plate baking paint with decorative lights
Sightseeing wall: Three pieces of safety glue glass

Cage wall: Stainless steel titanium plate

Handrail: Stainless steel single pipe

Floor: PVC floor



GE-CD-974

Upper and lower cover: Organic plate with metal strip and five deformation steel plate

Sightseeing wall: Safety clip glass

Decorative top: Image board with tube lamp

Cage wall: Mirror, hair line, etching, concave gold

Handrail: Stainless steel double pipe

Floor: PVC floor



OPERATION PANEL



GE-COP-012 **Standard Solution**

Optional display

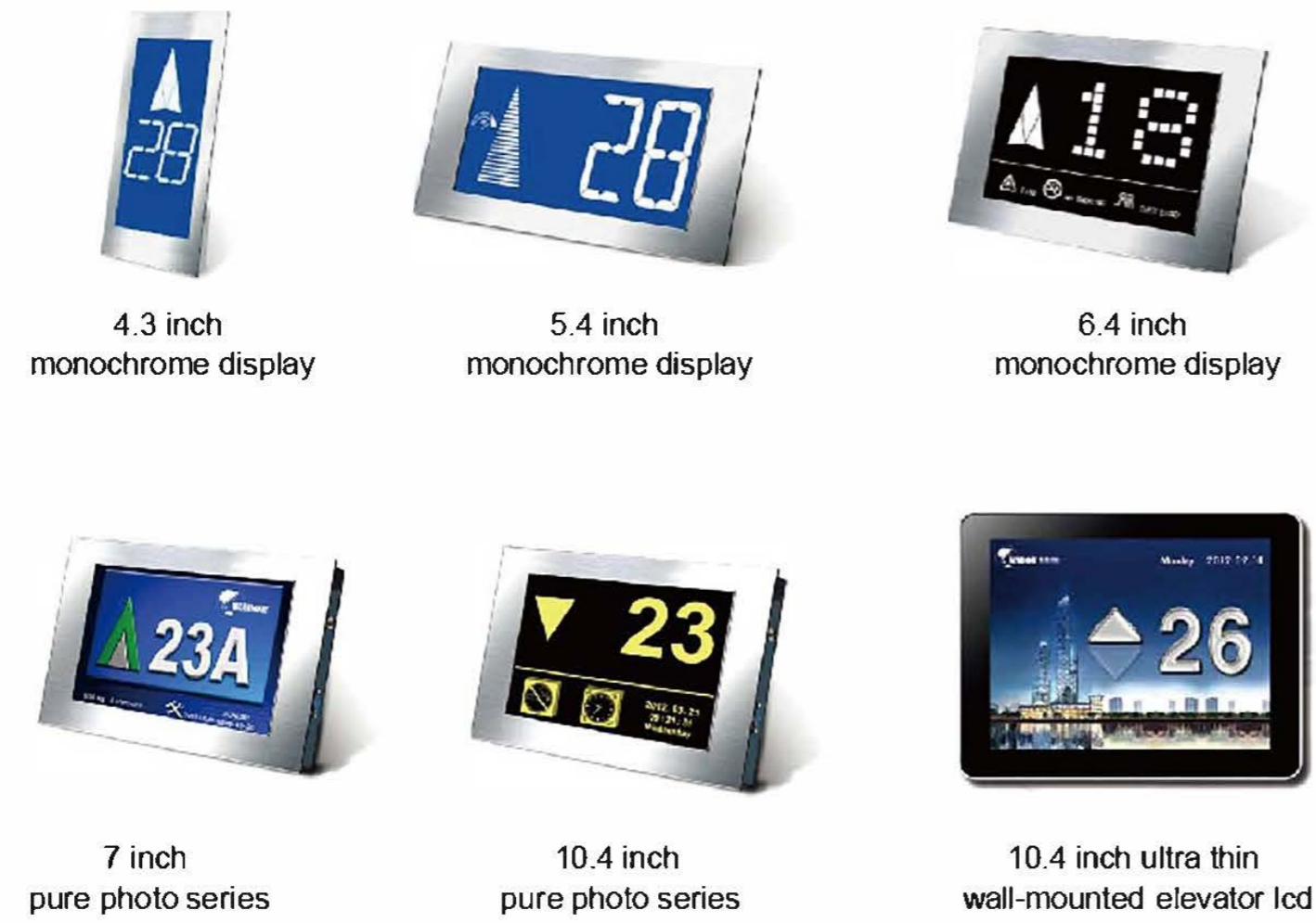

Optional button



Direction lantern

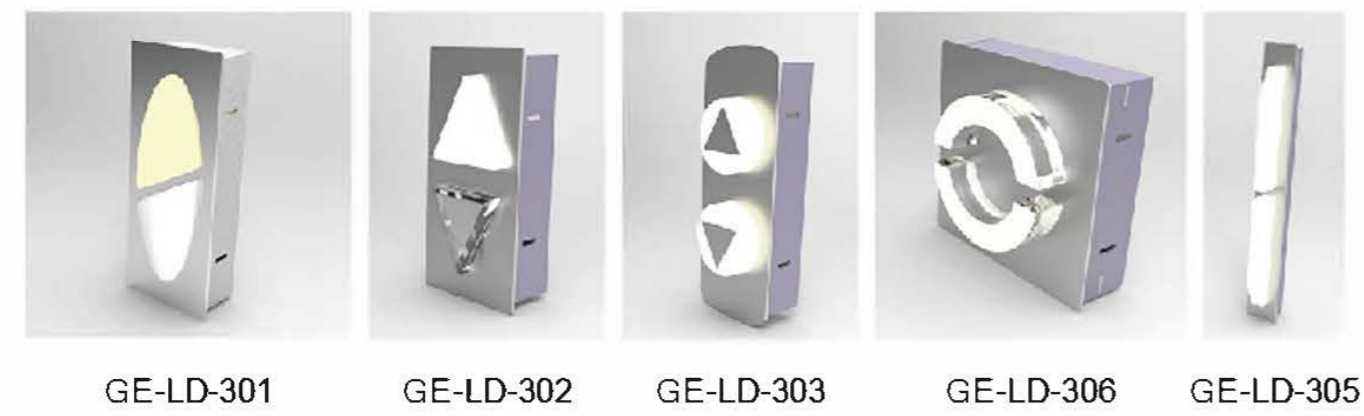

Operation panel series



GE-COP-080 **Economic Solution**

GE-COP-020 **Modern Solution**

GE-COP-102 **Luxury Solution**

ELEVATOR CEILING SERIES

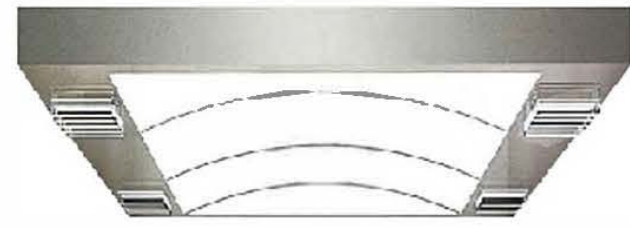

GE-CC-501

White arch light-emitting panel, stainless steel mirror frame, strip light decoration



GE-CC-502

Titanium gold stainless steel mirror base-plate is supplemented with rectangle hollow transparent light pole, central soft lighting design of white organic panel

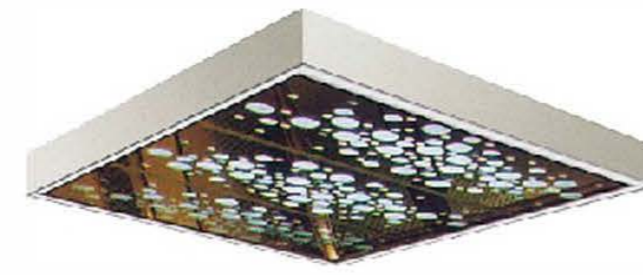

GE-CC-503

Stainless steel mirror hollow panel, white organic panel, mirror stainless steel frame



GE-CC-519

Round art panel model, rear soft lighting design of down lamp



GE-CC-520

Round steel bar model, white organic panel, rear soft lighting design of down lamp



GE-CC-521

Round hollow art panel model, rear soft lighting design of down lamp



GE-CC-504

Stainless steel titanium gold mirror hollow panel, white light-emitting panel, mirror stainless steel frame



GE-CC-505

Stainless steel mirror hollow panel, white organic panel, mirror stainless steel frame



GE-CC-506

Stainless steel mirror hollow panel, white organic panel, aluminum alloy frame



GE-CC-522

Round glass model, rear soft lighting design of down lamp



GE-CC-523

Round lotus pattern art panel, rear soft lighting design of down lamp



GE-CC-524

Central white ceiling lamp, four-side stainless steel base plate with soft lighting design of down lamp



GE-CC-507

Stainless steel mirror hollow panel, white organic panel, aluminum alloy frame



GE-CC-508

Mirror stainless steel panel is supplemented with rectangle hollow transparent light pole, central soft lighting design of white organic light-emitting panel

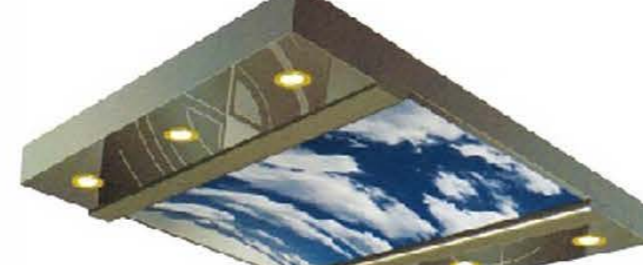

GE-CC-510

Central image arch, two-side stainless steel base-plate is supplemented with soft lighting design of down lamp (image to be provided by client)

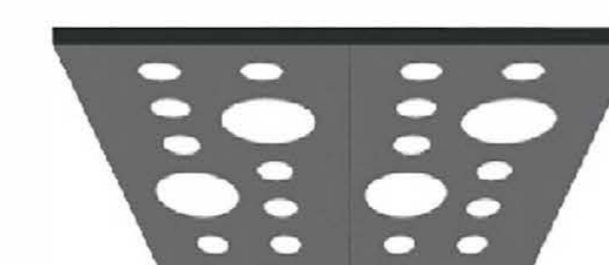

GE-CC-527

Stainless steel frame, white acrylic light-emitting



GE-CC-528

Stainless steel square tube frame, mirror stainless steel, down light



GE-CC-529

Stainless steel side frame + soft lighting design of arch white light-emitting panel

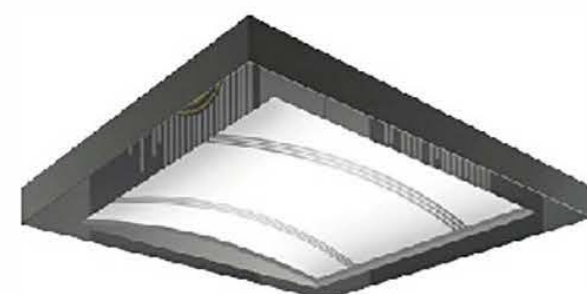

GE-CC-511

Soft lighting design of broad arch white light-emitting panel



GE-CC-515

Central image arch, two-side stainless steel base plate, soft lighting design of down lamp

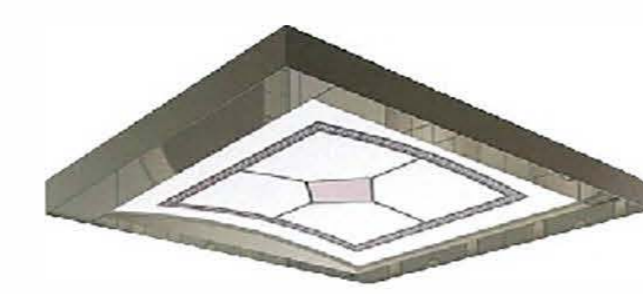

GE-CC-518

Soft lighting design of broad image arch



GE-CC-530

Stainless steel side frame + soft lighting design of arch white light-emitting panel



GE-CC-531

Stainless steel square tube frame, mirror stainless steel, down light



GE-CC-532

Stainless steel side frame + soft lighting design of arch white light-emitting panel

ELEVATOR PANEL SERIES



GE-DP-301 **Standard**
Solution ▲ Mirror, Hairline, Etched



GE-DP-302 **Standard**
Solution ▲ Mirror, Etched



GE-DP-334 **Standard**
Solution ▲ Mirror, Etching, Concave Golden



GE-DP-343 **Economic**
Solution ▲ Mirror, Etched, Hairline



GE-DP-347 **Economic**
Solution ▲ Mirror, Etched, Hairline



GE-DP-348 **Economic**
Solution ▲ Mirror, Etched



GE-DP-337 **Standard**
Solution ▲ Mirror, Etching, Golden, Hairline



GE-DP-356 **Standard**
Solution ▲ Mirror, Etching, Hairline



GE-DP-363 **Standard** Solution ▲ Mirror, Etching, Hairline, Concave Golden



GE-DP-323 **Luxury** Solution ▲ Mirror, Etched, Rose gold



GE-DP-336 **Luxury** Solution ▲ Mirror, Etched, Titanium Golden



GE-DP-339 **Luxury** Solution ▲ Mirror, Etched



GE-DP-427 **Standard** Solution ▲ Titanium, Mirror, Etching



GE-DP-321 **Standard** Solution ▲ Mirror, Hairline



GE-DP-322 **Economic** Solution ▲ Mirror, Etched



GE-DP-388 **Luxury** Solution ▲ Mirror, Etching, Titanium Golden



GE-DP-395 **Luxury** Solution ▲ Mirror, Etching, Titanium Golden



GE-DP-396 **Luxury** Solution ▲ Mirror, Hairline, Titanium Golden

ELEVATOR FLOOR SERIES



OPTIONAL COLORS



ELEVATOR HANDRAIL SERIES

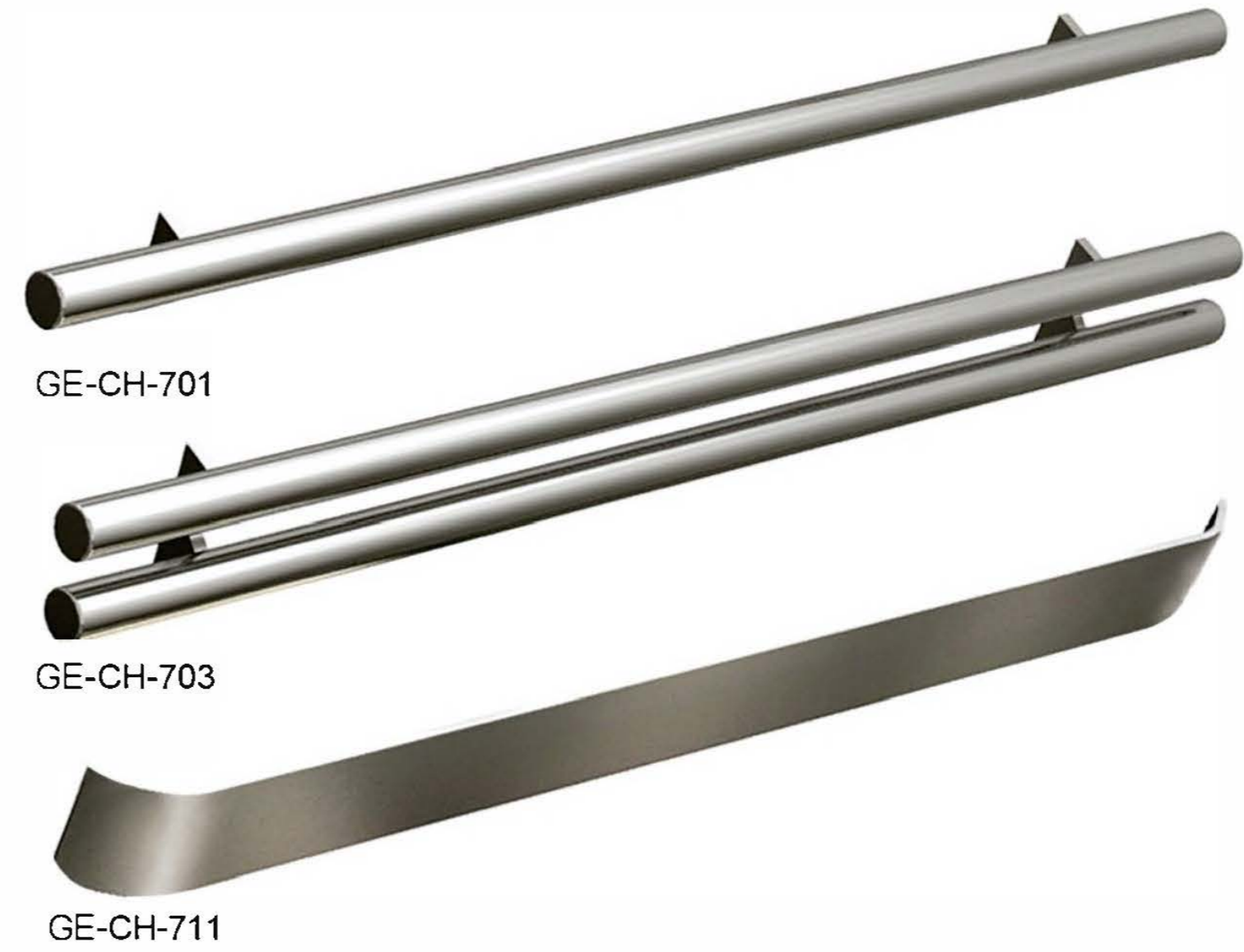

FREIGHT ELEVATOR



▼ A loading giant that can release more and more cargo pressures for you

SUNNY freight lift serial fully utilizes the advanced and fully computerized control technology. It employs the well-developed VVVF control system of SUNNY elevator. It is simple in structure and convenient in repair and maintenance. It fulfills a qualitative leap in the aspects of the signal transmission and running control. It brings about the more stable and reliable system, the lower noise, the smoother running, the more accurate leveling. It is more and more easy for the goods entry and exit. In addition, SUNNY freight lift serial can offer the micro-processor. The high speed running capabilities and expansion interface ensure to satisfy the special requirements from broad users.



▼ Light curtain protection

Several protective light curtains are formed at the entrance of the elevator, which sensibly detects and responds to any objects that intrude into the detecting scope. The safety of human and cargoes are guaranteed.

▼ The extremely humane operation

It is equipped with fully automatic collective selective function. It can fulfill operation with driver / without driver. The operation box specially and additionally sets "door-shut delay" button in the operation box. Door-shut delay time can be flexibly adjusted at site according to the requirements. You feel more at ease at loading and unloading the goods out of its humane setting.

Freight Elevator Construction Sketch

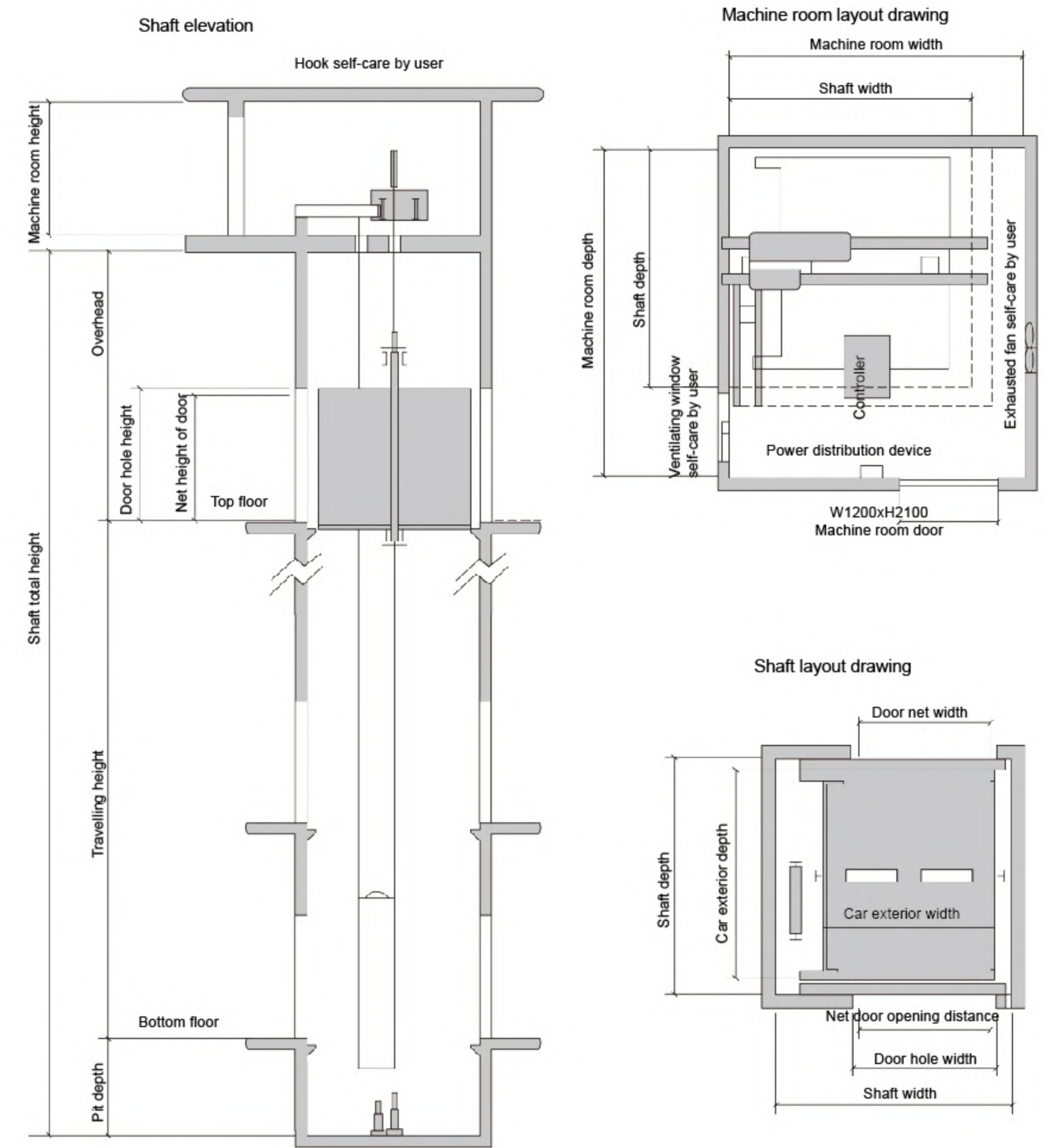

Freight elevator parameter table

Load (kg)	Speed (m/s)	Net size of car(mm)	Net size of door(mm)	Shaft net size(mm)			Machine room net size(mm)		Door open type
		C.WxC.DxD.H	D.WxD.H	width x depth	Overhead height	Pit depth	width x depth	height	
630	0.5	1200*1500*2200	1100*2100	2100*1860	4200	1500	2500*3000	2200	Two panel side opening
1000	0.5	1500*1800*2200	1200*2100	2250*2160	4200	1500	3000*3000	2200	Two panel side opening
2000	0.5	1570*2900*2200	1500*2100	2700*3260	4200	1500	3500*3000	2500	Two panel side opening
	1.0				4500	1500			
	1.5	2000*2300*2200	2850*2660	4500	1600	Four panel center opening			
2.0		4800	1800						
3000	0.25	2070*3050*2200	1800*2100	3300*3410	4500	1500	3800*4200	2500	Four panel center opening
0.5									
3200	1.0	2070*3100*2200	1800*2100	3300*3460	4500	1500	3800*4200	2500	Four panel center opening
5000	0.25	2800*3400*2500	2000*2200	4200*3800	5000	1600	4200*3800	2800	Four panel center opening
	0.5								
7000	0.25	3000*4200*2500	2600*2400	4500*4600	5000	1600	4500*4600	2800	Four panel center opening
	0.5								
10000	0.25	3070*5760*2500	2600*2400	4900*6200	5000	1600	4900*6200	2800	Four panel center opening

Note: Reference only, for detail information, please contact SUNNY elevator.

CAR ELEVATOR



Perfect Space for Cars

We develop and produce SUNNY automobile elevator through absorption, transformation and enhancement by introducing the world's, well-developed automobile elevation technology. The powerful technical capacity of SUNNY reduces the traction system burden due to uneven force to the elevator car. It solves the technical obstacle of shaking elevator car due to noise production. It optimizes the characteristics of the product series.



⚡ Dual operation panels design(Optional)

There are two operation box in the car. Therefore the driver can operate the elevator in the car without slapping out of it.



⚡ Special-purpose circuit control and display system

Special circuit control and display system is convenient for the drivers inside/outside the car.



⚡ Front-and-rear opening elevator car

The elevator car sets front/rear door opening which is more convenient for the safety sector and for the cars to enter into/exit from the elevator cars.

Car Elevator Construction Sketch

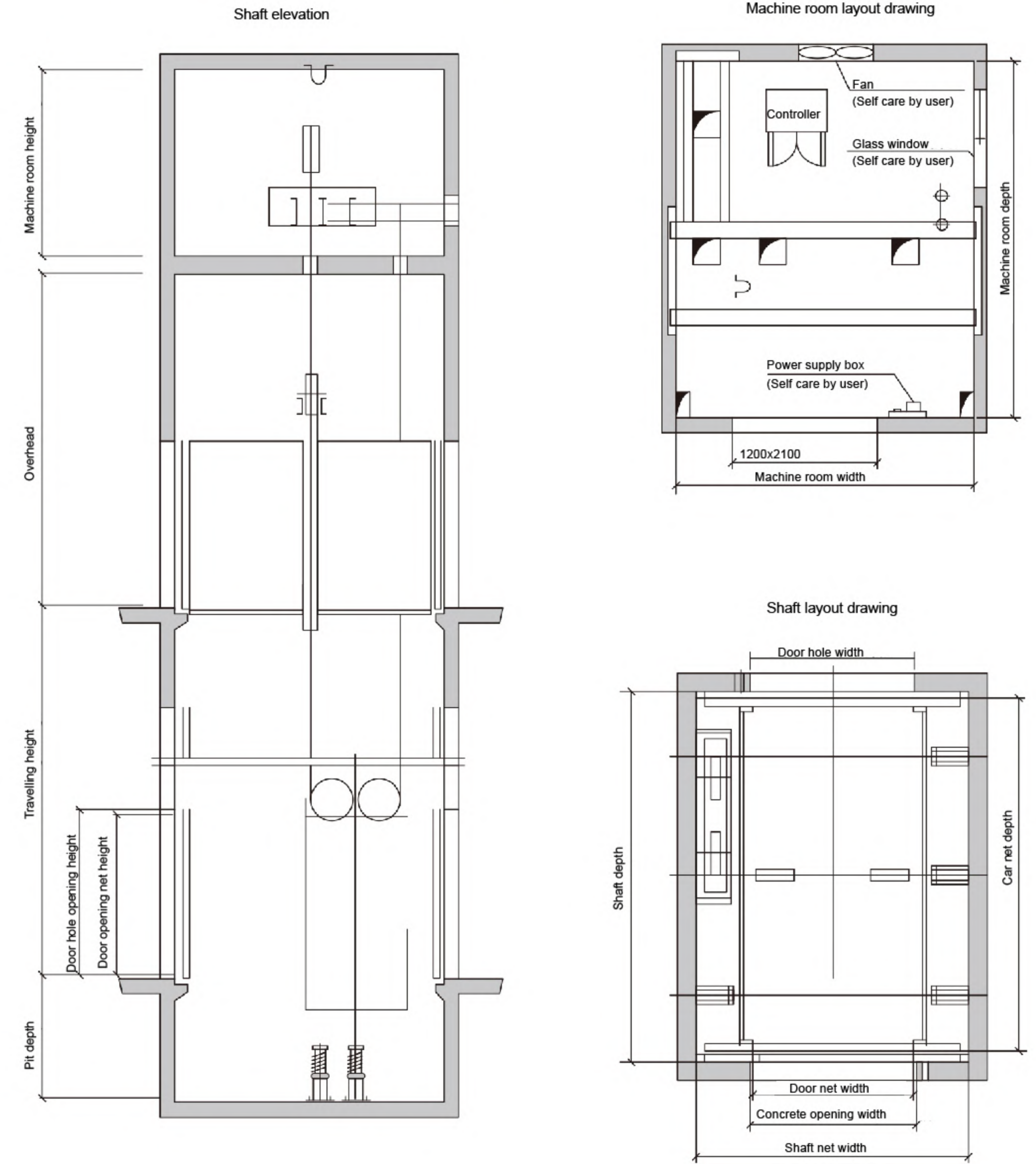

Car elevator parameter table

Load (kg)	Speed (m/s)	Door open type	Net door opening widthxheight(mm)	Exterior size of car widthxdepth(mm)	Shaft net size(mm)			Machine room net size(mm) widthxdepthxheight
					widthxdepth	pit depth	overhead height	
3000	0.25/0.5	Four Panel Center Opening	2400*2200	2700*5800	4100*6160	1600	4800	4100*6160*2500
5000	0.25 0.5	Four Panel Center Opening	2600*2200	3500*7200	4750*7560			4750*7560*2500

Note:Reference only, for detail information,please contact SUNNY elevator.

FREIGHT ELEVATOR CAR DECORATION

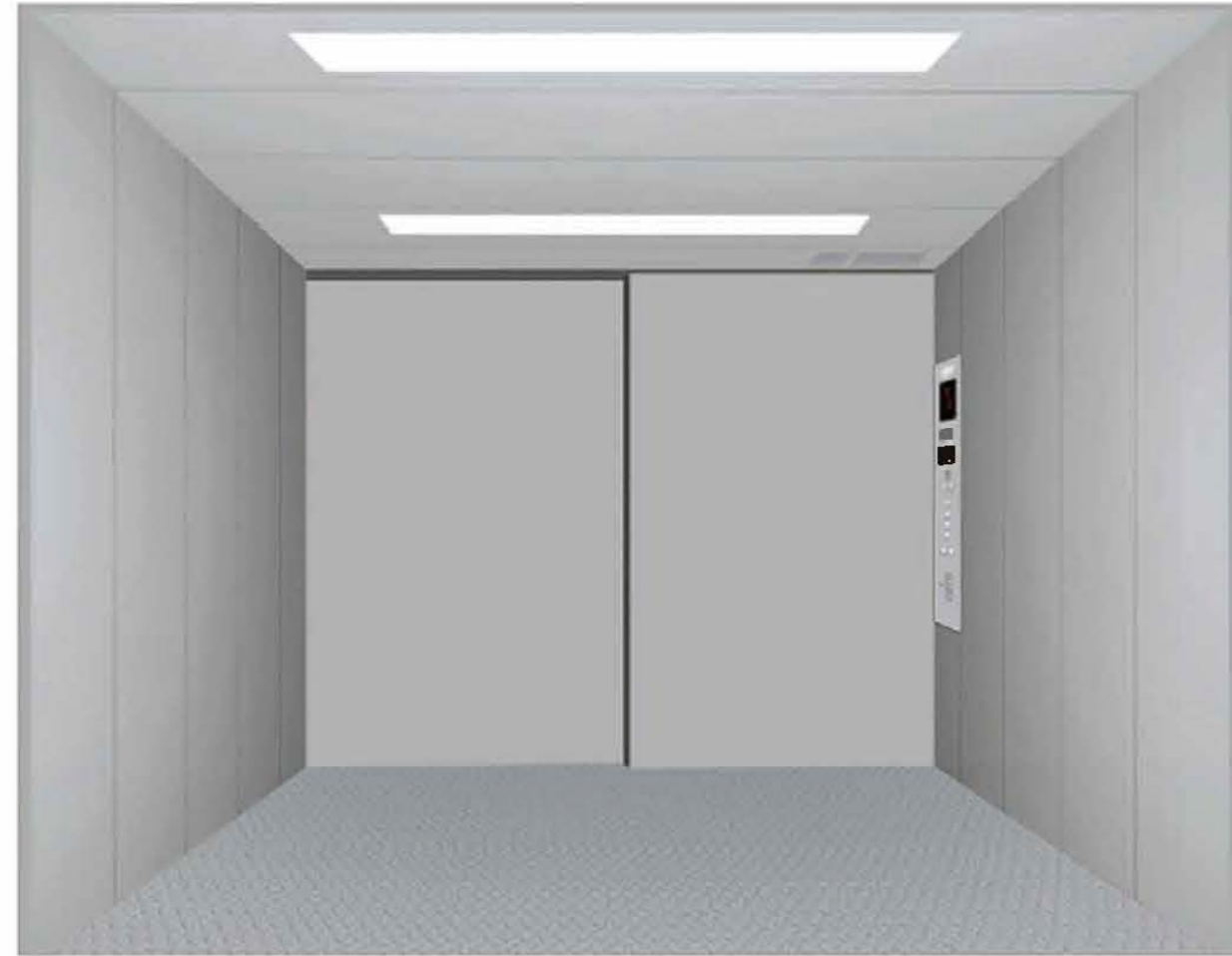

Side Opening

GE-CD-F100 (Standard)

Item	Specification
Car ceiling	Painted panel,energy-saving light
Ventilation	Square fan
Car wall	Painted panel(Standard) Hairline stainless steel(Optional)
Car door	Painted panel(Standard) Hairline stainless steel(Optional)
Floor	Checked stainless steel plate
Sill	Steel sill(Open width> 1500) Reinforced aluminum alloy(Open width≤1500)

GE-CD-F200 (Standard)

Item	Specification
Car ceiling	Painted panel,energy-saving light
Ventilation	Round fan
Car wall	Painted panel(Standard) Hairline stainless steel(Optional)
Car door	Painted panel(Standard) Hairline stainless steel(Optional)
Floor	Checked stainless steel plate
Sill	Steel sill(Open width> 1500) Reinforced aluminum alloy(Open width≤1500)



Double-folded Center Opening Type

OPERATION PANEL



GE-COP-160
Operation panel:Hairline stainless steel

FLOOR

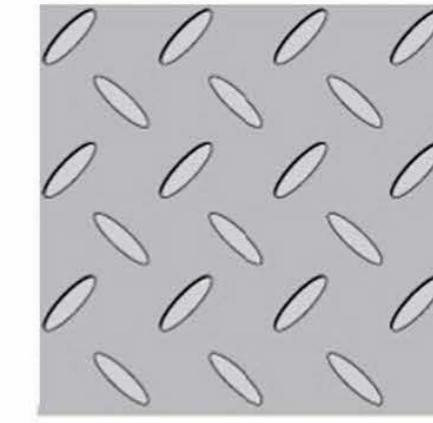

Ordinary checked
steel plate I
(Standard)



Ordinary checked
steel plate II
(Optional)

CRASH BARRIER



Wooden



Rubber

LANDING DOOR



Center opening



Side opening



Double-folded
center opening type



3-Folded
center opening type

POWDER COATING COLOR(OPTIONAL)



ice gray

GE-SK001



plane gray

GE-SK002



corny yellow

GE-SK003



light green

GE-SK007

ESCALATOR



Perfect Model Brings About The Better Riding Experience

Extremely long life, energy efficient delivery, stable and reliable performance, will be on your right-hand man, is the best carrying tools. SUNNY escalator to the excellent performance, practical and flexible design to meet different customer needs. Priority use of microcomputer variable frequency(VVVF) and ergonomics research and advanced manufacturing technology, SUNNY escalator is more perfect, safe, comfortable, energy-saving, easy miantenance.

Optimized Design Saves The Space

Minimum span size greatly saves the occupied space. The compact pit depth design brings about a freer construction layout.

City Large-flow Traffic Solution Plan Specialist

It innovatively combines with human-centered ideas. It has the advanced stairway and belt design. It is smooth and comfortable in operation. Solemn and smooth handrail entry, traffic flow light appear bright and dynamic. It perfectly connects with inner/outer cover plates, skirting plate, frontline plate. It smoothly transits to big arc rotary end handrail.

SUNNY escalators are widely applicable for the airport, railway station, high grade hotel, CBD, large-size shopping center, public facilities etc. It adds a brilliant sight line for modern building.

- Its truss adapt the superior profile steel with unique structure, high intensity, through anti-rusting, good effect, long life.
- The advanced international manufacture craft, technology, general assembly, tooling guarantee the precise elevator path.
- Super-strong CPU master-board computer control executes real-time monitor to the running conditions. It automatically stops at any abnormal conditions. It also promptly and automatically makes records, displays the trouble code.



30° ESCALATOR CONSTRUCTION SKETCH

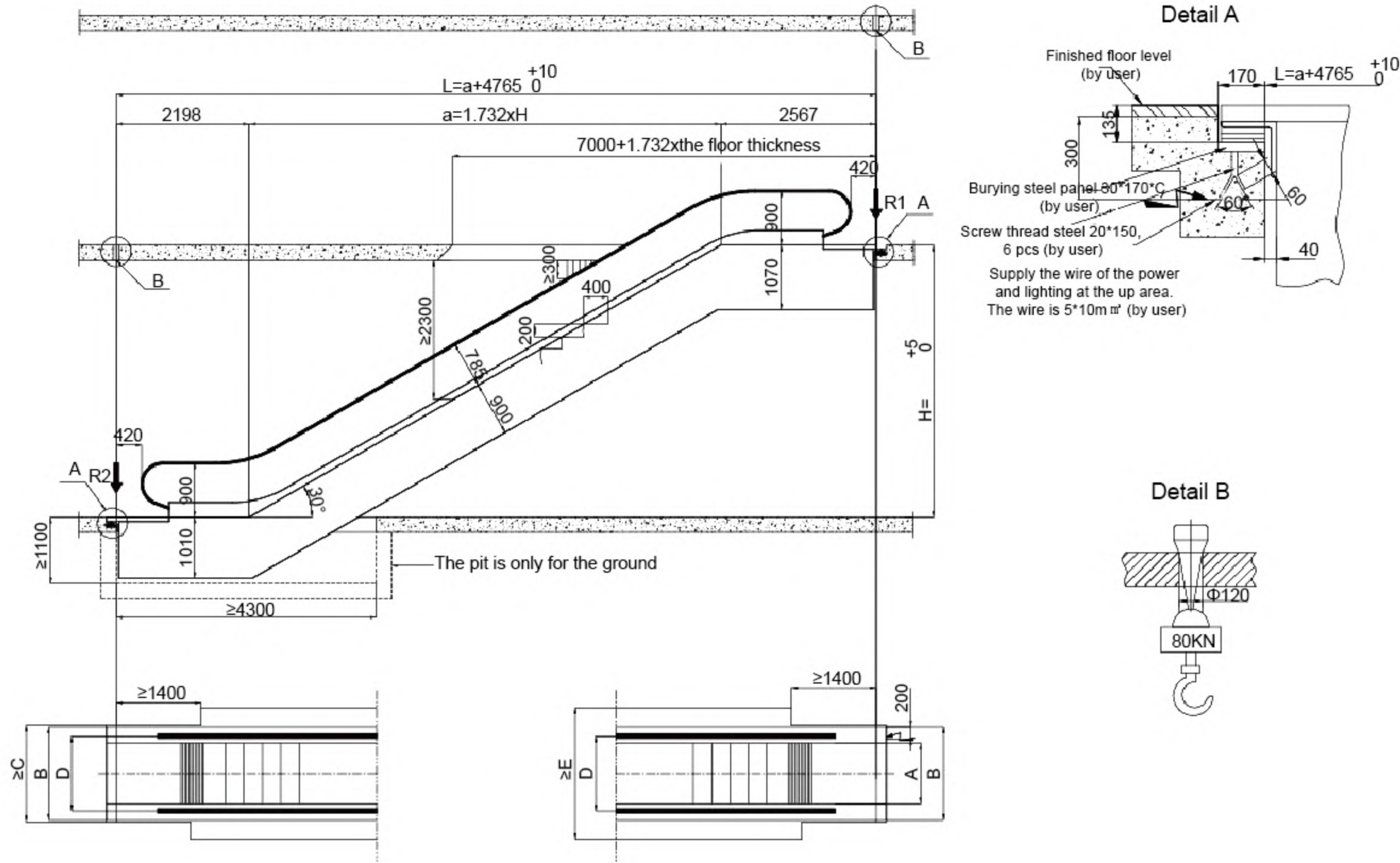

35° ESCALATOR CONSTRUCTION SKETCH

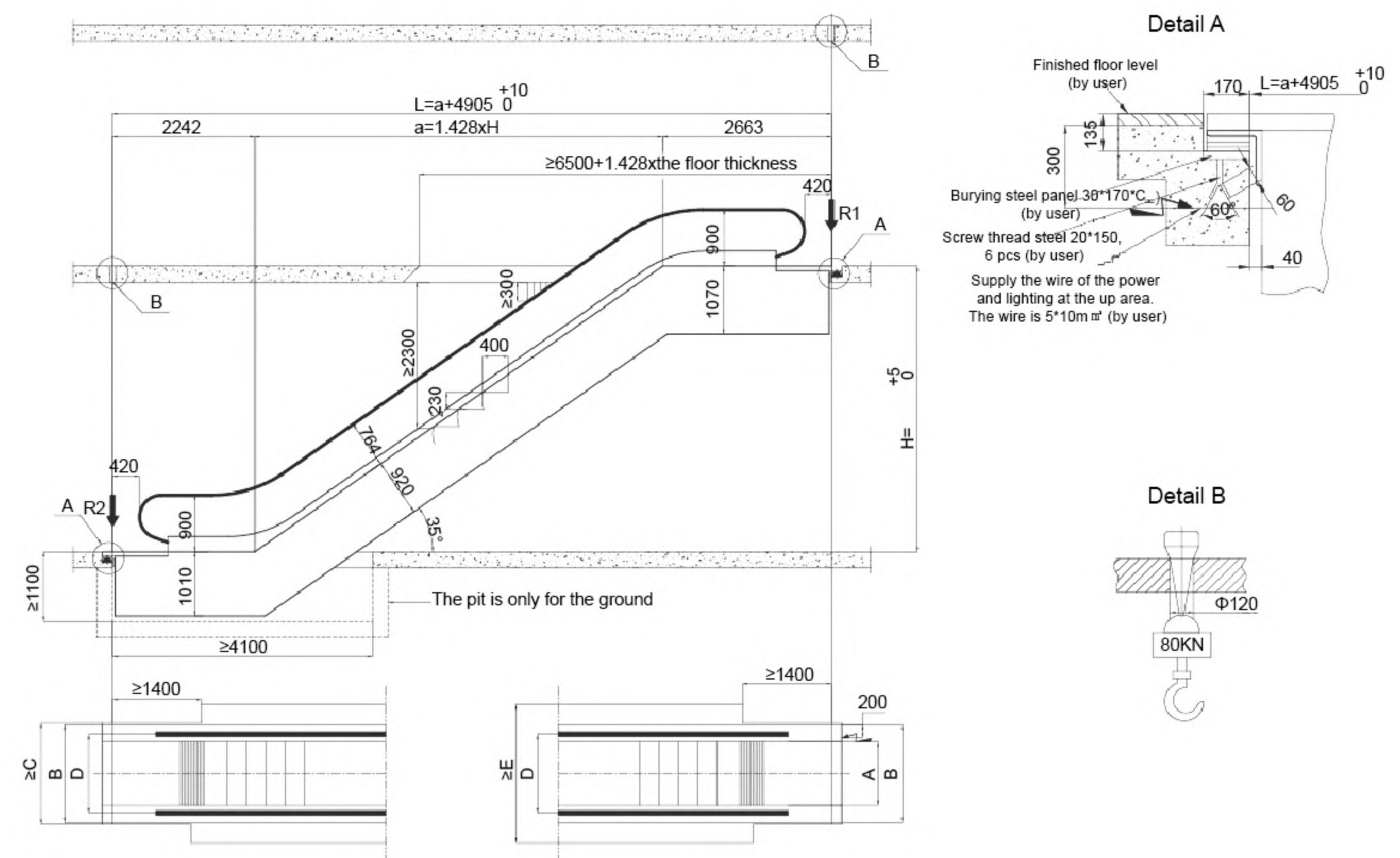

Reacting force

Step width	600	800	1000	Remark
R1(KN)	3.5xL+15.5	4xL+17	4.5xL+18.5	L=m
R2(KN)	3.5xL+10	4xL+11	4.5xL+11.5	

Power meter(Step width 1000mm speed 0.5m/s)

	5.5KW	8KW	11KW
	1.5m≤H≤3.2m	3.2m<H≤4.8m	4.8m<H≤6.0m

Table of rules of extension interior escalator's upper part

	Power				
	Step width	<15KW	15KW	2X11KW	2X15KW
Without VVVF	600	417	417		
	800	0	0	500	
	1000	0	0	500	800
With VVVF	600	417	417		
	800	0	200	500	
	1000	0	0	500	800

Standard specification and dimension

Model	SN-ES-600	SN-ES-800	SN-ES-1000
Step width	A 600	800	1000
Decorating width	B 1140	1340	1540
Construction open width	C 1200	1400	1600
Space between handrail	D 838	1038	1238
Construction open width	E 1778	1978	2178

Notes

* The layout drawing is suitable for the construction which the height is below 6m.
* If the step width is 600mm, 417mm shall be extended at the up of the truss.

		Specification parameter
Type		SN-ES-600-30
		SN-ES-800-30
		SN-ES-1000-30
Speed		0.5m/s
Rise height		H≤6000mm
Angle		30°
Supporting R1		KN
Supporting R2		KN
Weight W		KN
Power	Power supply	Three-phase AC 380V 50HZ
	Lighting supply	Single-phase AC 220V 50HZ

Reacting force

Step width	600	800	1000	Remark
R1(KN)	3.5xL+15.5	4xL+17	4.5xL+18.5	L=m
R2(KN)	3.5xL+10	4xL+11	4.5xL+11.5	

Power meter(Step width 1000mm speed 0.5m/s)

	5.5KW	8KW	11KW
	1.5m≤H≤3.5m	3.5m<H≤5.0m	5.0m<H≤6.0m

Table of rules of extension interior escalator's upper part

	Power				
	Step width	<15KW	15KW	2X11KW	2X15KW
Without VVVF	600	417	417		
	800	0	0	500	
	1000	0	0	500	800
With VVVF	600	417	417		
	800	0	200	500	
	1000	0	0	500	800

Standard specification and dimension

Model	SN-ES-600	SN-ES-800	SN-ES-1000
Step width	A 600	800	1000
Decorating width	B 1140	1340	1540
Construction open width	C 1200	1400	1600
Space between handrail	D 838	1038	1238
Construction open width	E 1778	1978	2178

Notes

* The layout drawing is suitable for the construction which the height is below 6m.
* If the step width is 600mm, 417mm shall be extended at the up of the truss.

		Specification parameter
Type		SN-ES-600-35
		SN-ES-800-35
		SN-ES-1000-35
Speed		0.5m/s
Rise height		H≤6000mm
Angle		35°
Supporting R1		KN
Supporting R2		KN
Weight W		KN
Power	Power supply	Three-phase AC 380V 50HZ
	Lighting supply	Single-phase AC 220V 50HZ

MOVING WALK



Extremely strong conveying capacities

- Moving walk has extremely strong conveying capacity. It can satisfy the traffic requirements of modern people in various aspects. It is applicable for the airport, shopping center, hotel, recreation center etc.
- Its unique and innovative design has minimum requirements to the space. Its firm structure is strong enough for any kind of load. At the same time of conveying large-size shopping plaza and busy airport; bus station, it saves every piece of precious space. It fully considers the requirements of modern city traffic.
- 0-12° angle of inclination can be freely choice according to different use and enviroment in the building.

Perfect Experience, Whole Hearted Contribution of Ghazi Elevator

Ghazi Elevator moving walk suits the occasions of large passenger flow, long operation time, long-distance delivery of passengers; luggage and goods. It follows the world's high tech development trend. It applies the advanced manufacture craft & technology. It goes all out to put out Ghazi Elevator moving walk, 0~12° multiple styles are available for the users' free choices. Ghazi Elevator moving walks are widely applicable for available big shopping malls, aviation ports, super-markets, recreation centers etc. It solves big carrying problems of large passenger flows. It satisfies long-distance walk, carrying of luggage cart; baby's cart; shopping cart; wheel chair for the disabled and so on. It is as easily as walking on a firm earth. It is greatly convenient for people's outing and shopping.

Ghazi Elevator moving walk on behalf of the new trend of industry-leading manufacturing, innovative, stylish, streamlined design and creative styling, make the product look gorgeous and dignified, dignity and style of the highlights with the support of the building, moving walk and architecture harmony between, seamless, complement to each other.

Ghazi Elevator moving walk shape luxurious, very stylish aesthetic, harmonious integration and the metropolis modern architecture and interior, the perfect interpretation of new state of the art technology, safe and reliable, energy saving, smooth and comfortable design concept.



12° MOVING WALK CONSTRUCTION SKETCH

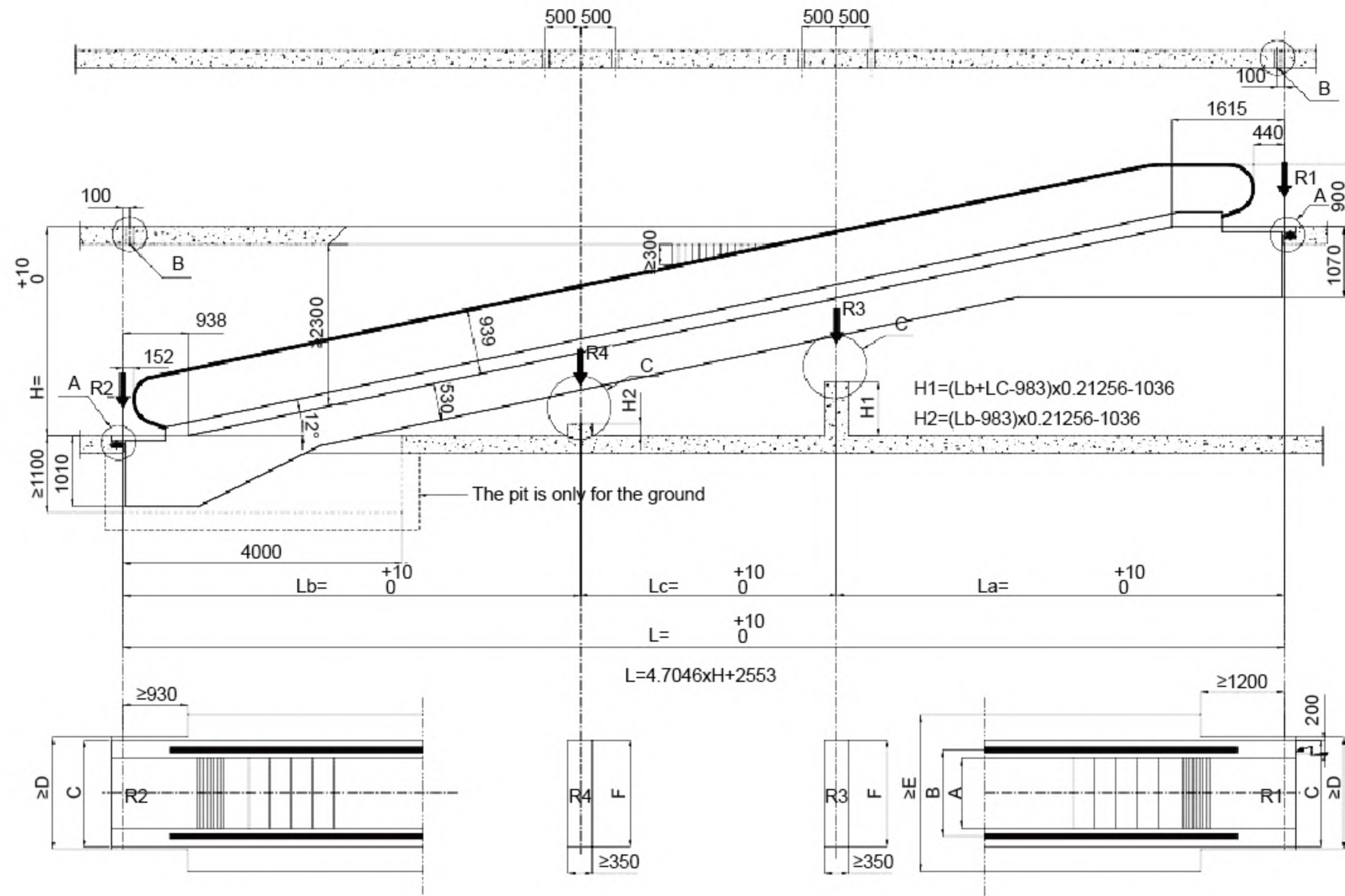

Detail A

Detail B

Detail C

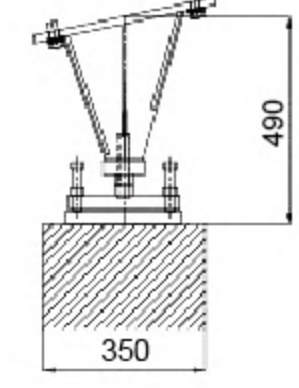
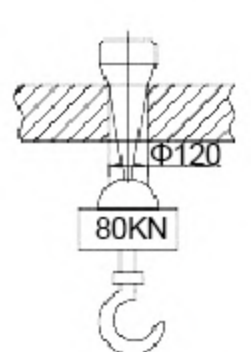
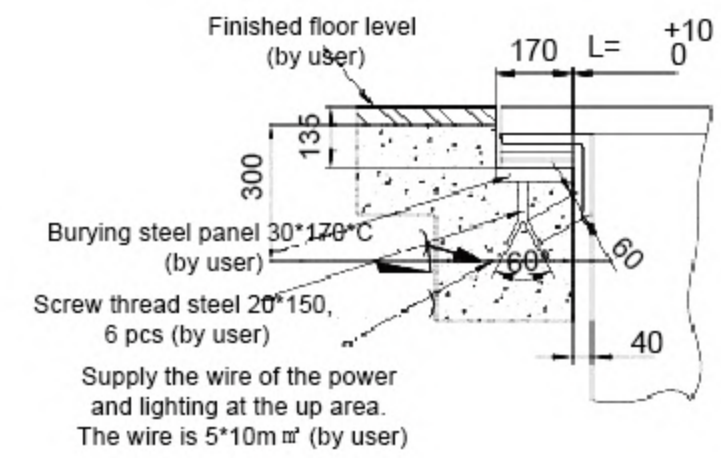

Step width	800	1000
A	800	1000
B	1038	1238
C	1340	1540

Power meter(Pedal width 1000mm speed 0.5m/s)

5.5KW	8KW	11KW
1.2m<H<3.0m	3.0m<H<4.5m	4.5m<H<6.0m
15KW		
6.0m<H<7.0m		

Supporting strength parameter	q	M	N	D	Specification parameter		
					1400	1600	
800	0.0039	9.5	4.5	E	2050	2250	
1000	0.0045	11	5	F	1340	1540	
Angle	Rise height		Middle support		La	Lb	Lc
	From	To	R3	R4			
12°	1601	2663	-	-	-	-	-
	2664	5851	1	-	L/2	L/2	-
	5852	8000	1	1	L/3	L/3	L/3

Table of rules of extension interior moving walk's upper part

	Power				
	Step width	<15KW	15KW	2X11KW	2X15KW
Without VVVF	800	0	0	500	800
	1000	0	0	500	800
With VVVF	800	0	200	500	800
	1000	0	0	500	800

	Supporting		
	Without middle support (KN)	Single middle support (KN)	Double middle support (KN)
R1=Lxq+M	R1=Lxq+M	R1=Lxq+M	R1=Lxq+M
R2=Lxq+N	R2=Lxq+N	R2=Lxq+N	R2=Lxq+N
R3=(La+Lb)x1.3xq	R3=(La+Lb)x1.3xq	R3=(La+Lc)x1.3xq	R3=(La+Lc)x1.3xq
R4=(Lb+Lc)x1.3xq	R4=(Lb+Lc)x1.3xq		

Notes		Specification parameter	
* The layout drawing is suitable for the construction which the height is below 7m.		Type	SN-ES-800-12 SN-ES-1000-12
		Speed	0.5m/s
		Rise height	H<7000mm
		Angle	12°
		Supporting R1	KN
		Supporting R2	KN
		Weight W	KN
Power	Power supply	Three-phase AC 380V 50HZ	
	Lighting supply	Single-phase AC 220V 50HZ	

0° MOVING WALK CONSTRUCTION SKETCH

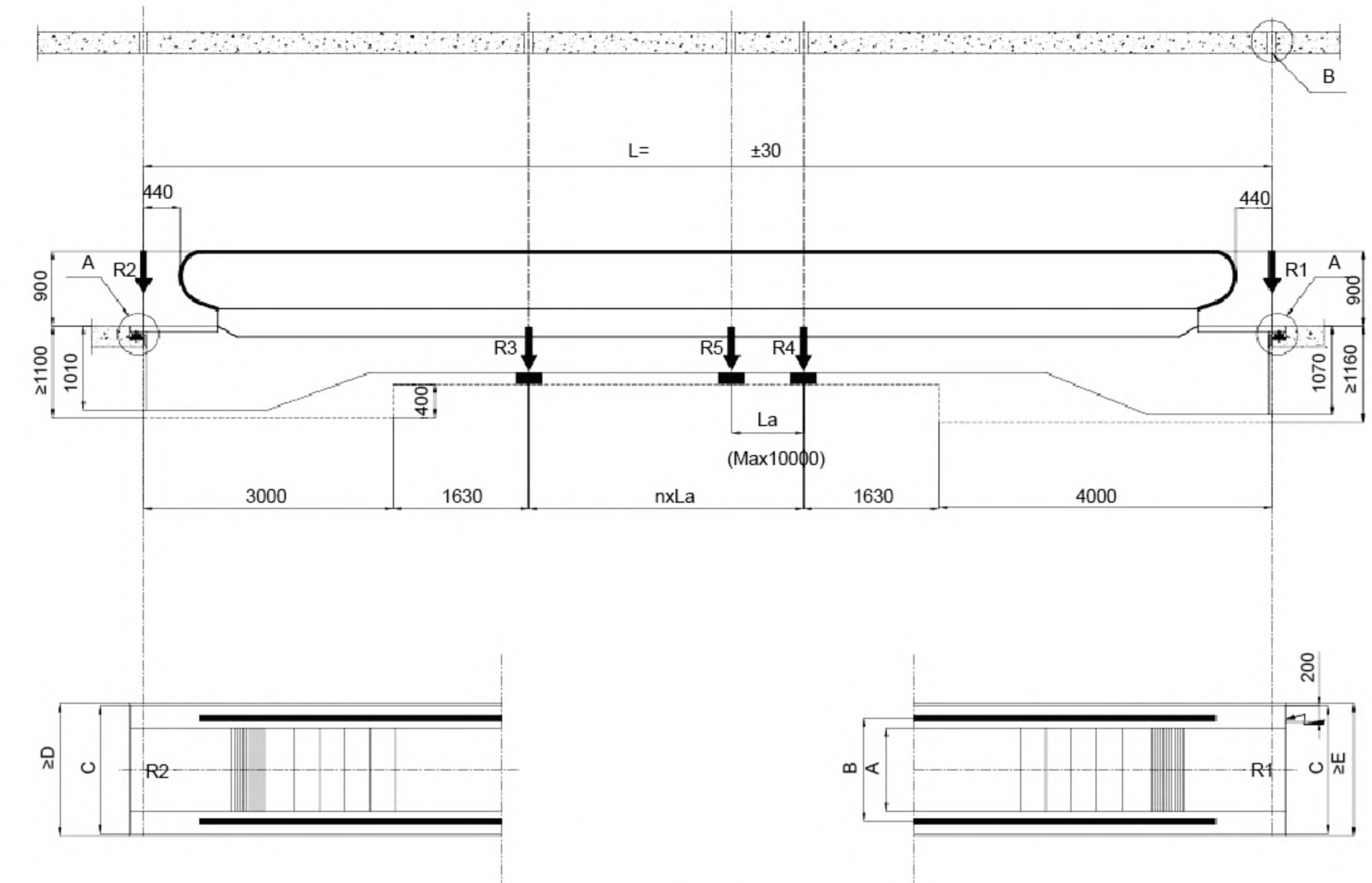

Detail A

Detail B

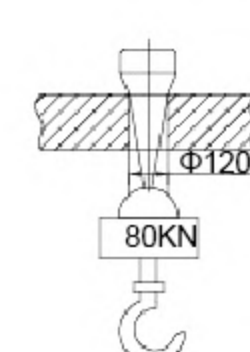
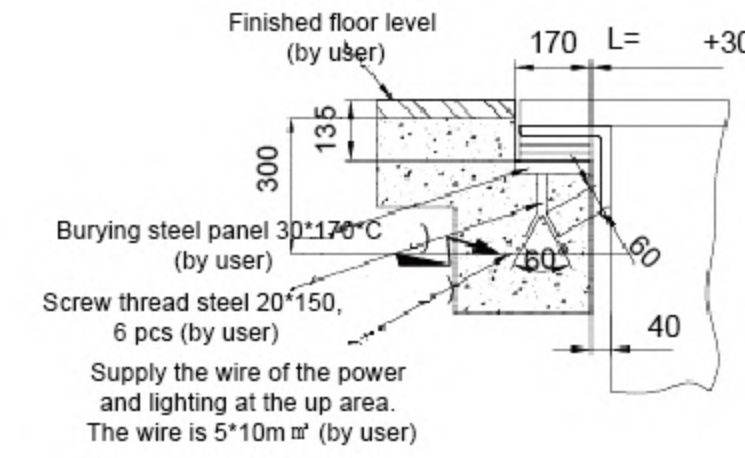

Power meter(Pedal width 1000mm speed 0.5m/s)

5.5KW	8KW	11KW
12m<L<50m	50m<L<72m	72m<L<100m

Table of rules of extension interior moving walk's upper part

	Power				
	Step width	<15KW	15KW	2X11KW	2X15KW
Without VVVF	800	0	0	500	800
	1000	0	0	500	800
With VVVF	800	0	200	500	800
	1000	0	0	300	800

	Step width		Step width	Step width	
	800	1000		800	1000
R1	32KN	36KN	A	800	1000
R2	31KN	33KN	B	1038	1238
R3	49KN	55KN	C	1340	1540
R4	50KN	57KN	D	1400	1600
R5	43KN	51KN	E	1400	1600

Notes		Specification parameter	
* This drawing is applicable to the civil construction of moving walkways.		Type	SN-ES-800-0 SN-ES-1000-0
		Speed	0.5m/s
		Horizontal span	L<100000mm
		Angle	0°
		Supporting R1	KN
		Supporting R2	KN
		Weight W	KN
Power	Power supply	Three-phase AC 380V 50HZ	
	Lighting supply	Single-phase AC 220V 50HZ	

